



**JOSAM**<sup>TM</sup>

**LIST PRICE  
GUIDE 2008**

**TABLE OF CONTENTS**

Closet Carriers.....	3-4
Fixture Carriers.....	5-6
Roof Drains .....	7-10
Floor Drains.....	11-18
Stainless Steel Products .....	18-19
Sanitary Floor Sinks.....	20-22
Cleanouts.....	23-25
Interceptors.....	26-29
Backwater Valves .....	30
Hydrants .....	31
Shock Absorbers.....	32
Trench Drains .....	32-33
Miscellaneous Products .....	33
Traps & Accessories.....	34-35
PVC Products .....	36

**HOW TO USE THIS PRICE GUIDE**

Every product in this guide is provided with list prices for the product and its options in a concise table. The description of each option is shown in the lower right corner of each page spread. A thumbnail photo is included for quick identification. All drawings and dimensions are available at [www.Josam.com](http://www.Josam.com).

All prices are list prices. Please consult your local Josam representative for your current multiplier.

Effective January 1, 2008

## Plumbing Drainage Guide – 2008 (PDG-2008)

Supersedes all previously published terms and conditions. Subject to change without notice.

Applicable to all sales of, and contracts to sell products of Josam Company

**CONTACT YOUR WHOLESALE FOR DETAILS ON DISCOUNT AND TERMS OF PAYMENT**

### **PAYMENT TERMS:**

For accounts with established credit, payment terms are 2% cash discount, payable 30 days from date of invoice, net 31 days. Invoices still unpaid after 31 days from date of invoice will be subject to interest charges of 1-1/2% per month. Minimum invoice: \$50.00 net. Confirmed irrevocable letter of credit or cash in advance of shipment is required for accounts without an established line of credit. Any terms and conditions appearing on your orders which are inconsistent with the terms of our quotation and conditions of sale shall be of no effect.

### **FREIGHT ALLOWANCE:**

All shipments will be F.O.B. Michigan City, Indiana or Service Center. A freight allowance will be made on all shipments of \$5,000.00 net amount or more within the continental USA except for Alaska, Hawaii and Puerto Rico. Full freight allowance is limited to normal ground services and does not include charges for specially expedited or guaranteed deliveries requiring air shipment or guaranteed motor freight contracts.

### **RETURN POLICY:**

Standard catalog material may be returned only upon written authorization of Seller. Credit will be issued to the Buyer's account toward purchase of additional material only. Obsolete, discontinued or specially produced items will not be accepted for return and credit.

When return results from causes involving Buyer's responsibility, credit for saleable goods returned will be issued at invoice price less a 25% restocking charge for handling and inspection. Return of less than \$100.00 net price will not be allowed. For other than saleable goods returned, any necessary charges to render the returned material saleable will be added. Galvanized material will be credited at the same value as painted cast iron. Chrome plated material will be credited at the value of satin finish bronze. On all returns, incoming and outgoing freight charges to and from Michigan City, Indiana, will be deducted from any credit allowed.

### **WARRANTY:**

Our products are warranted to be free of defects in material and workmanship, but our liability shall be limited solely to those defects, which our inspection finds to be due to our fault. Notification of a claim for defective material or workmanship must be given in writing to Josam Company, Michigan City, Indiana within 60 days from date of shipment. **WE SHALL NOT BE RESPONSIBLE FOR ANY LABOR CHARGES OR ANY LOSS, INJURY OR DAMAGES WHATSOEVER, INCLUDING INCIDENTAL OR CONSEQUENTIAL DAMAGES.** The sole and exclusive remedy shall be limited to the replacement or repair of the defective goods at the Seller's discretion. Before installation and use, Buyer shall determine the suitability of the product for his intended use and the Buyer assumes all risk and liability whatever in connection therewith.

### **QUOTATIONS:**

Quotations are based on discount in effect at the time of quotation and will be protected on this basis for a period of 30 days from job bid due date. If an order is received within this 30-day period, it must indicate a release of material for shipment within 60 days from date of order, and all released shipments will be protected at prices quoted. If order is not released by customer within this 60-day period, it will be priced at discount prevailing at time of shipment.

### **EXPORT ORDERS:**

Factors which govern export orders differ from domestic orders. Please contact Josam International.

### **ACCEPTANCE OF ORDERS:**

All catalogs, price lists or other literature describing our products are not to be construed as offers to sell same. All orders are subject to acceptance by the general office of Seller in Michigan City, Indiana, either by shipment or by written acceptance. Your order, when shipped or accepted by us, shall constitute the complete contract between us, subject to and incorporating therein the terms and conditions herein contained, and any inconsistent provisions contained in your order shall not apply. Prices, discounts and special programs contained in any of our catalogs, price lists or other literature are subject to change without notice.

### **CANCELLATION:**

Orders are not subject to cancellation without our written consent. If an order is cancelled, the Buyer shall pay all costs incurred in connection with filling the order. Any items not cataloged or items not normally stocked by us and made or purchased to fill the order become the Buyer's property and must be paid for by the Buyer.

### **ILLUSTRATIONS, DESCRIPTIONS AND DIMENSIONS:**

All illustrations, descriptions, and detailed dimensions represent standard features and do not necessarily indicate all variations available. All weights stated in our catalogs, literature and drawings are approximate and are not guaranteed.

All designs, descriptions and dimensions are subject to change without notice, and unless Buyer specifically states otherwise on order, standard products in effect at time order is shipped will be supplied.

### **RISKS:**

Our responsibility ceases after the product has been delivered to the carrier in good order. It is the responsibility of the consignee to inspect each shipment carefully and file a claim with the carrier for any damage or shortage. Content shortages must be reported within 15 days after receipt of material.



### **DELIVERY:**



Shipping dates are estimates and time of delivery is not the essence of this sale or the contract therefor. We will ship as near schedule as possible. Under no circumstances will the Seller have any responsibility on account of any delays in manufacture, transportation, or otherwise. Material is subject to shipment in whole or in part, at our option, and each shipment is subject to immediate invoicing.



### **TAXES:**

Any sales, or manufacturers' tax imposed under existing or future statutes shall be added to the price herewith effective and shall be paid by the Buyer unless proper exemption certificates are filed with Josam Company.

**JOSAM COMPANY • MICHIGAN CITY, INDIANA 46360 • PHONE: (800) 365-6726 • FAX: (800) 627-0008**

  <b>12684</b> Opposite (Not Shown)  <b>12694</b> 	HORIZONTAL NO-HUB ADJUSTABLE			
	LIST PRICE			
SERIES NO.	12674 Single L.H.	12684 Single R.H.	12694 Back-to-Back	
No-Hub	\$694.00	\$694.00	\$1,295.00	
-HS	694.00	694.00	1,295.00	
-58	873.00	873.00	1,474.00	
-HS-58	873.00	873.00	1,474.00	
ADD FOR OPTIONS:				
-PF.....	\$0.00	-10.....	\$0.00	
-OR.....	0.00	-24*.....	Deduct 67.00	
-SD*.....	318.00	-30.....	0.00	
-HS.....	0.00	-30-2.....	0.00	
-AUX**.....	159.00	-32*.....	211.00	
-VP*.....	57.00	-35.....	0.00	
-1*.....	36.00	-58.....	179.00	
-6*.....	37.00			
* Pricing for options is per fixture. Add or subtract twice for Back-to-Back Carriers				
** Not Available on 12694.				











  <b>14024</b> Opposite (Not Shown)  <b>14044</b> 	VERTICAL CLOSE HUB & SPIGOT, OFFSET		
	LIST PRICE		
SERIES NO			
14004 Sgl. L.H., L.H. 2" Vent	\$623.00		
14024 Sgl. R.H., R.H. 2" Vent	623.00		
14044 Back-to-Back, 2" Vent	1,066.00		
ADD FOR OPTIONS:			
-VP*.....	\$57.00	-21*.....	\$143.00
-1*.....	36.00	-54.....	159.00
-6*.....	37.00		
* Pricing for options is per fixture. Add or subtract twice for Back-to-Back Carriers			

  <b>12714</b> 	VERTICAL ADJUSTABLE SINGLE, NO-HUB, ON STACK		
	LIST PRICE		
SERIES NO	No-Hub	-HS	
12704 L.Hand 2" Vent	\$785.00	\$819.00	
12714 R.Hand 2" Vent	785.00	819.00	
ADD FOR OPTIONS:			
-PF.....	\$0.00	-6.....	\$37.00
-OR.....	0.00	-10.....	0.00
-SD.....	318.00	-24.....	Deduct 67.00
-HS.....	34.00	-30.....	0.00
-LH4.....	134.00	-30-2.....	0.00
-HLH4.....	134.00	-32.....	211.00
-RH4.....	134.00	-35.....	0.00
-HRH4.....	134.00	-49.....	159.00
-D4.....	269.00	-50.....	159.00
-HD4.....	269.00	-53.....	159.00
-VP.....	57.00	-54.....	159.00
-1.....	36.00		

### OPTION DESCRIPTIONS

- AUX Auxiliary Inlet, 2"
- D4 Double 4" No-Hub Branches
- HD4 Double 4" Hub Branches
- HLH4 Left-Hand 4" Hub Branch
- HRH4 Right-Hand 4" Hub Branch
- HS Hub & Spigot
- HVS4 Vent Side 4" Hub Branch
- LH4 Left-Hand 4" No-Hub Branch
- OR O-Ring Carrier
- OS4 Opposite Vent 4" No-Hub Branch
- PF Pylon Foot, Standard
- RH4 Right-Hand 4" No-Hub Branch
- SD Special-Duty 500 lb. Carrier
- VP Vandal-Proof Trim
- VS4 Vent Side 4" No-Hub Branch
- 1 Positioning Frame
- 6 Supply Pipe Support (Specify Galvanized or Copper Pipe)
- 10 ABS Extension through 10-1/2" Wall
- 21 Hanger Type Closet Adapter
- 24 Carrier for Floor-Mounted, Back-Outlet China Bowls
- 30 Cast Iron Adjustable Extension with Connector
- 30-2 Cast Iron Adjustable Extension with Connector and Test Cap
- 32 Carrier for Wide Chase Installations
- 35 Closet Carrier for Wheelchair High Rough
- 49 No-Hub High Auxiliary Inlet, Under Vent
- 50 No-Hub High Auxiliary Inlet, Opposite Vent
- 53 Threaded High Auxiliary Inlet, Under Vent
- 54 Threaded High Auxiliary Inlet, Opposite Vent
- 58 Horizontal No-Hub Cast Long Barrel

	VERTICAL ADJUSTABLE BACK-TO-BACK, NO-HUB, ON STACK		
	LIST PRICE		
SERIES NO	No-Hub	-HS	
12724 Back-to-Back 2" Vent	\$1,389.00	\$1,423.00	
ADD FOR OPTIONS:			
-PF.....	\$0.00	-6.....	74.00
-OR.....	0.00	-10.....	\$0.00
-SD.....	636.00	-24.....	Deduct 134.00
-HS.....	34.00	-30.....	0.00
-D4.....	269.00	-30-2.....	0.00
-HD4.....	269.00	-32.....	422.00
-VS4.....	134.00	-35.....	0.00
-OS4.....	134.00	-49.....	159.00
-HVS4.....	134.00	-50.....	159.00
-VP.....	114.00	-53.....	159.00
-1.....	72.00	-54.....	159.00

<p><b>14064</b></p>  <p><b>14104</b></p> 	<p style="text-align: center;"><b>VERTICAL CLOSE HUB &amp; SPIGOT, ON STACK</b></p> <table border="1" style="width: 100%;"> <thead> <tr> <th colspan="2" style="text-align: center;">LIST PRICE</th> </tr> </thead> <tbody> <tr> <td colspan="2"><b>SERIES NO</b></td> </tr> <tr> <td>14064 Sgl., 4" Vent</td> <td style="text-align: right;">\$623.00</td> </tr> <tr> <td>14104 Sgl., 2" Vent</td> <td style="text-align: right;">623.00</td> </tr> <tr> <td colspan="2"><b>ADD FOR OPTIONS:</b></td> </tr> <tr> <td>-SD .....</td> <td style="text-align: right;">\$318.00</td> </tr> <tr> <td>-VP .....</td> <td style="text-align: right;">57.00</td> </tr> <tr> <td>-1 .....</td> <td style="text-align: right;">36.00</td> </tr> <tr> <td>-6 .....</td> <td style="text-align: right;">\$37.00</td> </tr> <tr> <td>-45 .....</td> <td style="text-align: right;">159.00</td> </tr> <tr> <td>-46 .....</td> <td style="text-align: right;">159.00</td> </tr> </tbody> </table>	LIST PRICE		<b>SERIES NO</b>		14064 Sgl., 4" Vent	\$623.00	14104 Sgl., 2" Vent	623.00	<b>ADD FOR OPTIONS:</b>		-SD .....	\$318.00	-VP .....	57.00	-1 .....	36.00	-6 .....	\$37.00	-45 .....	159.00	-46 .....	159.00	<p><b>15964</b></p> 	<p style="text-align: center;"><b>90° INSTITUTIONAL FITTING VERTICAL NO-HUB, ON STACK</b></p> <table border="1" style="width: 100%;"> <thead> <tr> <th colspan="2" style="text-align: center;">LIST PRICE</th> </tr> </thead> <tbody> <tr> <td colspan="2"><b>SERIES NO</b></td> </tr> <tr> <td>15964 Double Waste Fitting with Vent and Carriers</td> <td style="text-align: right;">\$1,887.00</td> </tr> <tr> <td colspan="2"><b>ADD FOR OPTIONS:</b></td> </tr> <tr> <td>-VP .....</td> <td style="text-align: right;">\$114.00</td> </tr> <tr> <td>-1 .....</td> <td style="text-align: right;">72.00</td> </tr> <tr> <td>-6 .....</td> <td style="text-align: right;">74.00</td> </tr> <tr> <td>-10 .....</td> <td style="text-align: right;">0.00</td> </tr> <tr> <td>-24 .....</td> <td style="text-align: right;">Deduct 134.00</td> </tr> <tr> <td>-26 .....</td> <td style="text-align: right;">\$0.00</td> </tr> <tr> <td>-30 .....</td> <td style="text-align: right;">0.00</td> </tr> <tr> <td>-30-2 .....</td> <td style="text-align: right;">0.00</td> </tr> <tr> <td>-49 .....</td> <td style="text-align: right;">159.00</td> </tr> <tr> <td>-54 .....</td> <td style="text-align: right;">159.00</td> </tr> </tbody> </table>	LIST PRICE		<b>SERIES NO</b>		15964 Double Waste Fitting with Vent and Carriers	\$1,887.00	<b>ADD FOR OPTIONS:</b>		-VP .....	\$114.00	-1 .....	72.00	-6 .....	74.00	-10 .....	0.00	-24 .....	Deduct 134.00	-26 .....	\$0.00	-30 .....	0.00	-30-2 .....	0.00	-49 .....	159.00	-54 .....	159.00
LIST PRICE																																																					
<b>SERIES NO</b>																																																					
14064 Sgl., 4" Vent	\$623.00																																																				
14104 Sgl., 2" Vent	623.00																																																				
<b>ADD FOR OPTIONS:</b>																																																					
-SD .....	\$318.00																																																				
-VP .....	57.00																																																				
-1 .....	36.00																																																				
-6 .....	\$37.00																																																				
-45 .....	159.00																																																				
-46 .....	159.00																																																				
LIST PRICE																																																					
<b>SERIES NO</b>																																																					
15964 Double Waste Fitting with Vent and Carriers	\$1,887.00																																																				
<b>ADD FOR OPTIONS:</b>																																																					
-VP .....	\$114.00																																																				
-1 .....	72.00																																																				
-6 .....	74.00																																																				
-10 .....	0.00																																																				
-24 .....	Deduct 134.00																																																				
-26 .....	\$0.00																																																				
-30 .....	0.00																																																				
-30-2 .....	0.00																																																				
-49 .....	159.00																																																				
-54 .....	159.00																																																				
<p><b>14404</b></p>  <p><b>14424</b> Opposite (Not Shown)</p> <p><b>14444</b></p> 	<p style="text-align: center;"><b>VERTICAL CLOSE NO-HUB, OFFSET</b></p> <table border="1" style="width: 100%;"> <thead> <tr> <th colspan="2" style="text-align: center;">LIST PRICE</th> </tr> </thead> <tbody> <tr> <td colspan="2"><b>SERIES NO</b></td> </tr> <tr> <td>14404 Sgl. L.H., L.H. 2" Vent</td> <td style="text-align: right;">\$623.00</td> </tr> <tr> <td>14424 Sgl. R.H., R.H. 2" Vent</td> <td style="text-align: right;">623.00</td> </tr> <tr> <td>14444 Back-to-Back, 2" Vent</td> <td style="text-align: right;">1,066.00</td> </tr> <tr> <td colspan="2"><b>ADD FOR OPTIONS:</b></td> </tr> <tr> <td>-SD* .....</td> <td style="text-align: right;">\$318.00</td> </tr> <tr> <td>-VP* .....</td> <td style="text-align: right;">57.00</td> </tr> <tr> <td>-1* .....</td> <td style="text-align: right;">36.00</td> </tr> <tr> <td>-6* .....</td> <td style="text-align: right;">37.00</td> </tr> <tr> <td>-10 .....</td> <td style="text-align: right;">0.00</td> </tr> <tr> <td>-24* .....</td> <td style="text-align: right;">Deduct \$67.00</td> </tr> <tr> <td>-30 .....</td> <td style="text-align: right;">0.00</td> </tr> <tr> <td>-30-2 .....</td> <td style="text-align: right;">0.00</td> </tr> <tr> <td>-50 .....</td> <td style="text-align: right;">159.00</td> </tr> <tr> <td>-54 .....</td> <td style="text-align: right;">159.00</td> </tr> </tbody> </table> <p>* Pricing for options is per fixture. Add or subtract twice for Back-to-Back Carriers</p>	LIST PRICE		<b>SERIES NO</b>		14404 Sgl. L.H., L.H. 2" Vent	\$623.00	14424 Sgl. R.H., R.H. 2" Vent	623.00	14444 Back-to-Back, 2" Vent	1,066.00	<b>ADD FOR OPTIONS:</b>		-SD* .....	\$318.00	-VP* .....	57.00	-1* .....	36.00	-6* .....	37.00	-10 .....	0.00	-24* .....	Deduct \$67.00	-30 .....	0.00	-30-2 .....	0.00	-50 .....	159.00	-54 .....	159.00	<p><b>15984</b></p> 	<p style="text-align: center;"><b>90° INSTITUTIONAL FITTING VERTICAL NO-HUB, ON STACK</b></p> <table border="1" style="width: 100%;"> <thead> <tr> <th colspan="2" style="text-align: center;">LIST PRICE</th> </tr> </thead> <tbody> <tr> <td colspan="2"><b>SERIES NO</b></td> </tr> <tr> <td>15984 Double Waste Fitting, No-Hub Branches, 2" Vent</td> <td style="text-align: right;">\$718.00</td> </tr> <tr> <td colspan="2"><b>ADD FOR OPTIONS:</b></td> </tr> <tr> <td>-26 .....</td> <td style="text-align: right;">\$0.00</td> </tr> <tr> <td>-49 .....</td> <td style="text-align: right;">159.00</td> </tr> <tr> <td>-54 .....</td> <td style="text-align: right;">\$159.00</td> </tr> </tbody> </table>	LIST PRICE		<b>SERIES NO</b>		15984 Double Waste Fitting, No-Hub Branches, 2" Vent	\$718.00	<b>ADD FOR OPTIONS:</b>		-26 .....	\$0.00	-49 .....	159.00	-54 .....	\$159.00				
LIST PRICE																																																					
<b>SERIES NO</b>																																																					
14404 Sgl. L.H., L.H. 2" Vent	\$623.00																																																				
14424 Sgl. R.H., R.H. 2" Vent	623.00																																																				
14444 Back-to-Back, 2" Vent	1,066.00																																																				
<b>ADD FOR OPTIONS:</b>																																																					
-SD* .....	\$318.00																																																				
-VP* .....	57.00																																																				
-1* .....	36.00																																																				
-6* .....	37.00																																																				
-10 .....	0.00																																																				
-24* .....	Deduct \$67.00																																																				
-30 .....	0.00																																																				
-30-2 .....	0.00																																																				
-50 .....	159.00																																																				
-54 .....	159.00																																																				
LIST PRICE																																																					
<b>SERIES NO</b>																																																					
15984 Double Waste Fitting, No-Hub Branches, 2" Vent	\$718.00																																																				
<b>ADD FOR OPTIONS:</b>																																																					
-26 .....	\$0.00																																																				
-49 .....	159.00																																																				
-54 .....	\$159.00																																																				
<p><b>14464</b></p>  <p><b>14484</b></p> 	<p style="text-align: center;"><b>VERTICAL CLOSE NO-HUB, ON STACK</b></p> <table border="1" style="width: 100%;"> <thead> <tr> <th colspan="2" style="text-align: center;">LIST PRICE</th> </tr> </thead> <tbody> <tr> <td colspan="2"><b>SERIES NO</b></td> </tr> <tr> <td>14464 Single, 4" Vent</td> <td style="text-align: right;">\$623.00</td> </tr> <tr> <td>14484 Back-to-Back, 4" Vent Siphon Jet Closets Only</td> <td style="text-align: right;">1,102.00</td> </tr> <tr> <td colspan="2"><b>ADD FOR OPTIONS:</b></td> </tr> <tr> <td>-SD* .....</td> <td style="text-align: right;">\$318.00</td> </tr> <tr> <td>-VP* .....</td> <td style="text-align: right;">57.00</td> </tr> <tr> <td>-1* .....</td> <td style="text-align: right;">36.00</td> </tr> <tr> <td>-6* .....</td> <td style="text-align: right;">37.00</td> </tr> <tr> <td>-10 .....</td> <td style="text-align: right;">0.00</td> </tr> <tr> <td>-24* .....</td> <td style="text-align: right;">Deduct \$67.00</td> </tr> <tr> <td>-30 .....</td> <td style="text-align: right;">0.00</td> </tr> <tr> <td>-30-2 .....</td> <td style="text-align: right;">0.00</td> </tr> <tr> <td>-45 .....</td> <td style="text-align: right;">159.00</td> </tr> <tr> <td>-46 .....</td> <td style="text-align: right;">159.00</td> </tr> </tbody> </table> <p>* Pricing for options is per fixture. Add or subtract twice for Back-to-Back Carriers</p>	LIST PRICE		<b>SERIES NO</b>		14464 Single, 4" Vent	\$623.00	14484 Back-to-Back, 4" Vent Siphon Jet Closets Only	1,102.00	<b>ADD FOR OPTIONS:</b>		-SD* .....	\$318.00	-VP* .....	57.00	-1* .....	36.00	-6* .....	37.00	-10 .....	0.00	-24* .....	Deduct \$67.00	-30 .....	0.00	-30-2 .....	0.00	-45 .....	159.00	-46 .....	159.00	<p><b>16123</b></p> 	<p style="text-align: center;"><b>FLOOR-MOUNT PVC ADAPTER TYPE, ON STACK</b></p> <table border="1" style="width: 100%;"> <thead> <tr> <th colspan="2" style="text-align: center;">LIST PRICE</th> </tr> </thead> <tbody> <tr> <td colspan="2"><b>SERIES NO</b></td> </tr> <tr> <td>16123 Single, for PVC Pipe Siphon Jet Closets Only</td> <td style="text-align: right;">\$448.00</td> </tr> <tr> <td colspan="2"><b>ADD FOR OPTIONS:</b></td> </tr> <tr> <td>-VP .....</td> <td style="text-align: right;">\$57.00</td> </tr> <tr> <td>-1 .....</td> <td style="text-align: right;">36.00</td> </tr> <tr> <td>-6 .....</td> <td style="text-align: right;">37.00</td> </tr> <tr> <td>-13 .....</td> <td style="text-align: right;">\$0.00</td> </tr> <tr> <td>-21 .....</td> <td style="text-align: right;">143.00</td> </tr> </tbody> </table>	LIST PRICE		<b>SERIES NO</b>		16123 Single, for PVC Pipe Siphon Jet Closets Only	\$448.00	<b>ADD FOR OPTIONS:</b>		-VP .....	\$57.00	-1 .....	36.00	-6 .....	37.00	-13 .....	\$0.00	-21 .....	143.00		
LIST PRICE																																																					
<b>SERIES NO</b>																																																					
14464 Single, 4" Vent	\$623.00																																																				
14484 Back-to-Back, 4" Vent Siphon Jet Closets Only	1,102.00																																																				
<b>ADD FOR OPTIONS:</b>																																																					
-SD* .....	\$318.00																																																				
-VP* .....	57.00																																																				
-1* .....	36.00																																																				
-6* .....	37.00																																																				
-10 .....	0.00																																																				
-24* .....	Deduct \$67.00																																																				
-30 .....	0.00																																																				
-30-2 .....	0.00																																																				
-45 .....	159.00																																																				
-46 .....	159.00																																																				
LIST PRICE																																																					
<b>SERIES NO</b>																																																					
16123 Single, for PVC Pipe Siphon Jet Closets Only	\$448.00																																																				
<b>ADD FOR OPTIONS:</b>																																																					
-VP .....	\$57.00																																																				
-1 .....	36.00																																																				
-6 .....	37.00																																																				
-13 .....	\$0.00																																																				
-21 .....	143.00																																																				
<p><b>14504</b></p> 	<p style="text-align: center;"><b>VERTICAL CLOSE NO-HUB, ON STACK</b></p> <table border="1" style="width: 100%;"> <thead> <tr> <th colspan="2" style="text-align: center;">LIST PRICE</th> </tr> </thead> <tbody> <tr> <td colspan="2"><b>SERIES NO</b></td> </tr> <tr> <td>14504 Single, 2" Vent</td> <td style="text-align: right;">\$623.00</td> </tr> <tr> <td colspan="2"><b>ADD FOR OPTIONS:</b></td> </tr> <tr> <td>-SD .....</td> <td style="text-align: right;">\$318.00</td> </tr> <tr> <td>-VP .....</td> <td style="text-align: right;">57.00</td> </tr> <tr> <td>-1 .....</td> <td style="text-align: right;">36.00</td> </tr> <tr> <td>-6 .....</td> <td style="text-align: right;">37.00</td> </tr> <tr> <td>-10 .....</td> <td style="text-align: right;">0.00</td> </tr> <tr> <td>-24 .....</td> <td style="text-align: right;">Deduct \$67.00</td> </tr> <tr> <td>-30 .....</td> <td style="text-align: right;">0.00</td> </tr> <tr> <td>-30-2 .....</td> <td style="text-align: right;">0.00</td> </tr> <tr> <td>-45 .....</td> <td style="text-align: right;">159.00</td> </tr> <tr> <td>-46 .....</td> <td style="text-align: right;">159.00</td> </tr> </tbody> </table>	LIST PRICE		<b>SERIES NO</b>		14504 Single, 2" Vent	\$623.00	<b>ADD FOR OPTIONS:</b>		-SD .....	\$318.00	-VP .....	57.00	-1 .....	36.00	-6 .....	37.00	-10 .....	0.00	-24 .....	Deduct \$67.00	-30 .....	0.00	-30-2 .....	0.00	-45 .....	159.00	-46 .....	159.00	<p style="text-align: center;"><b>Closet Carrier OPTION DESCRIPTIONS</b></p> <ul style="list-style-type: none"> <li>-SD Special-Duty 500 lb. Carrier</li> <li>-VP Vandal-Proof Trim</li> <li>-1 Positioning Frame</li> <li>-6 Supply Pipe Support (Specify Galvanized or Copper Pipe)</li> <li>-10 ABS Extension through 10-1/2" Wall</li> <li>-13 3" ABS Fitting Adapter</li> <li>-21 Hanger Type Closet Adapter</li> <li>-24 Carrier for Floor-Mounted, Back-Outlet China Bowls</li> <li>-26 Fitting Anchor Foot</li> <li>-30 Cast Iron Adjustable Extension with Connector</li> <li>-30-2 Cast Iron Adjustable Extension with Connector and Test Cap</li> <li>-45 Threaded Left-Hand Auxiliary Inlet</li> <li>-46 Threaded Right-Hand Auxiliary Inlet</li> <li>-49 No-Hub High Auxiliary Inlet, Under Vent</li> <li>-50 No-Hub High Auxiliary Inlet, Opposite Vent</li> <li>-54 Threaded High Auxiliary Inlet, Opposite Vent</li> </ul>																							
LIST PRICE																																																					
<b>SERIES NO</b>																																																					
14504 Single, 2" Vent	\$623.00																																																				
<b>ADD FOR OPTIONS:</b>																																																					
-SD .....	\$318.00																																																				
-VP .....	57.00																																																				
-1 .....	36.00																																																				
-6 .....	37.00																																																				
-10 .....	0.00																																																				
-24 .....	Deduct \$67.00																																																				
-30 .....	0.00																																																				
-30-2 .....	0.00																																																				
-45 .....	159.00																																																				
-46 .....	159.00																																																				

	<p align="center"><b>REUSABLE ALIGNMENT TOOL</b></p> <table border="1"> <thead> <tr> <th colspan="3">LIST PRICE</th> </tr> </thead> <tbody> <tr> <td>TYPE NO.</td> <td>17000</td> <td>\$118.00</td> </tr> </tbody> </table>	LIST PRICE			TYPE NO.	17000	\$118.00		<p align="center"><b>WALL-MOUNT ADJUSTABLE EXPOSED ARMS</b></p> <table border="1"> <thead> <tr> <th colspan="3">LIST PRICE</th> </tr> </thead> <tbody> <tr> <td>TYPE NO.</td> <td>17390</td> <td>\$428.00</td> </tr> </tbody> </table> <p><b>ADD FOR OPTIONS:</b></p> <p>-BP.....\$0.00    -VP.....\$57.00    -10*.....\$21.00</p> <p>* Hardware for Walls over 4-1/2", Specify Wall Thickness, Price Per Inch</p>	LIST PRICE			TYPE NO.	17390	\$428.00																																						
LIST PRICE																																																					
TYPE NO.	17000	\$118.00																																																			
LIST PRICE																																																					
TYPE NO.	17390	\$428.00																																																			
	<p align="center"><b>FLOOR-MOUNT ADJUSTABLE CONCEALED ARMS</b></p> <table border="1"> <thead> <tr> <th colspan="3">LIST PRICE</th> </tr> </thead> <tbody> <tr> <td>TYPE NO.</td> <td>17100</td> <td>17100-BB</td> </tr> <tr> <td></td> <td>\$432.00</td> <td>\$615.00</td> </tr> </tbody> </table> <p><b>ADD FOR OPTIONS:</b></p> <table border="1"> <thead> <tr> <th colspan="2">17100</th> <th colspan="2">17100-BB</th> </tr> </thead> <tbody> <tr> <td>-BB</td> <td>\$183.00</td> <td>ABOVE</td> <td></td> </tr> <tr> <td>-10*</td> <td>21.00</td> <td>\$42.00</td> <td></td> </tr> <tr> <td>-60</td> <td>64.00</td> <td>128.00</td> <td></td> </tr> <tr> <td>-67</td> <td>29.00</td> <td>58.00</td> <td></td> </tr> <tr> <td>-75</td> <td>71.00</td> <td>142.00</td> <td></td> </tr> <tr> <td>-76</td> <td>129.00</td> <td>258.00</td> <td></td> </tr> <tr> <td>-77</td> <td>129.00</td> <td>258.00</td> <td></td> </tr> </tbody> </table> <p>* Extension Sleeves Longer than 6-1/2", Specify Wall Thickness, Price Per Inch.</p>	LIST PRICE			TYPE NO.	17100	17100-BB		\$432.00	\$615.00	17100		17100-BB		-BB	\$183.00	ABOVE		-10*	21.00	\$42.00		-60	64.00	128.00		-67	29.00	58.00		-75	71.00	142.00		-76	129.00	258.00		-77	129.00	258.00			<p align="center"><b>WALL-MOUNT EXPOSED ARMS ONLY</b></p> <table border="1"> <thead> <tr> <th colspan="3">LIST PRICE</th> </tr> </thead> <tbody> <tr> <td>TYPE NO.</td> <td>17405</td> <td>\$277.00</td> </tr> </tbody> </table> <p><b>ADD FOR OPTIONS:</b></p> <p>-VP.....\$57.00    -10*.....\$21.00</p> <p>* Hardware for Walls over 4", Specify Wall Thickness, Price Per Inch</p>	LIST PRICE			TYPE NO.	17405	\$277.00			
LIST PRICE																																																					
TYPE NO.	17100	17100-BB																																																			
	\$432.00	\$615.00																																																			
17100		17100-BB																																																			
-BB	\$183.00	ABOVE																																																			
-10*	21.00	\$42.00																																																			
-60	64.00	128.00																																																			
-67	29.00	58.00																																																			
-75	71.00	142.00																																																			
-76	129.00	258.00																																																			
-77	129.00	258.00																																																			
LIST PRICE																																																					
TYPE NO.	17405	\$277.00																																																			
	<p align="center"><b>WALL-MOUNT ADJUSTABLE CONCEALED ARMS</b></p> <table border="1"> <thead> <tr> <th colspan="3">LIST PRICE</th> </tr> </thead> <tbody> <tr> <td>TYPE NO.</td> <td>17120</td> <td>\$255.00</td> </tr> </tbody> </table> <p><b>ADD FOR OPTIONS:</b></p> <p>-BP .....\$0.00    -76 .....\$129.00          -MMB.....Deduct 54.00    -77 .....129.00          -10* ..... 21.00          -75 ..... 71.00</p> <p>* Extension Sleeves Longer than 4", Specify Wall Thickness, Price Per Inch</p>	LIST PRICE			TYPE NO.	17120	\$255.00		<p align="center"><b>FLOOR-MOUNT HANGER PLATE TYPE</b></p> <table border="1"> <thead> <tr> <th colspan="4">LIST PRICE</th> </tr> </thead> <tbody> <tr> <td>17550</td> <td>17550-BB</td> <td>17550-UR</td> <td>17550-WCBL</td> </tr> <tr> <td>\$ 327.00</td> <td>\$432.00</td> <td>\$327.00</td> <td>\$535.00</td> </tr> </tbody> </table> <p><b>ADD FOR OPTIONS:</b></p> <table border="1"> <thead> <tr> <th colspan="2">17550</th> <th colspan="2">17550-BB</th> </tr> </thead> <tbody> <tr> <td>-BB</td> <td>\$105.00</td> <td>ABOVE</td> <td></td> </tr> <tr> <td>-CL</td> <td>124.00</td> <td>----</td> <td></td> </tr> <tr> <td>-UR**</td> <td>0.00</td> <td>----</td> <td></td> </tr> <tr> <td>-WC**</td> <td>0.00</td> <td>----</td> <td></td> </tr> <tr> <td>-WCBL**</td> <td>208.00</td> <td>----</td> <td></td> </tr> <tr> <td>-10*</td> <td>21.00</td> <td>\$42.00</td> <td></td> </tr> <tr> <td>-60</td> <td>64.00</td> <td>128.00</td> <td></td> </tr> </tbody> </table> <p>* Hardware for Walls over 4", Specify Wall Thickness, Price Per Inch          ** Cannot be Furnished with -60</p>	LIST PRICE				17550	17550-BB	17550-UR	17550-WCBL	\$ 327.00	\$432.00	\$327.00	\$535.00	17550		17550-BB		-BB	\$105.00	ABOVE		-CL	124.00	----		-UR**	0.00	----		-WC**	0.00	----		-WCBL**	208.00	----		-10*	21.00	\$42.00		-60	64.00	128.00	
LIST PRICE																																																					
TYPE NO.	17120	\$255.00																																																			
LIST PRICE																																																					
17550	17550-BB	17550-UR	17550-WCBL																																																		
\$ 327.00	\$432.00	\$327.00	\$535.00																																																		
17550		17550-BB																																																			
-BB	\$105.00	ABOVE																																																			
-CL	124.00	----																																																			
-UR**	0.00	----																																																			
-WC**	0.00	----																																																			
-WCBL**	208.00	----																																																			
-10*	21.00	\$42.00																																																			
-60	64.00	128.00																																																			
	<p align="center"><b>WALL-MOUNT, NON-ADJUSTABLE CONCEALED ARMS</b></p> <table border="1"> <thead> <tr> <th colspan="3">LIST PRICE</th> </tr> </thead> <tbody> <tr> <td>TYPE NO.</td> <td>17125</td> <td>\$199.00</td> </tr> </tbody> </table> <p><b>ADD FOR OPTIONS:</b></p> <p>-10* .....\$21.00    -75.....\$71.00</p> <p>* Extension Sleeves Longer than 4", Specify Wall Thickness, Price Per Inch</p>	LIST PRICE			TYPE NO.	17125	\$199.00	<p align="center"><b>Fixture Carrier OPTION DESCRIPTIONS</b></p> <p>-BB    Back-to-Back Carrier          -BP    with Back Plates          -CL    Corner Lavatory Carrier          -HD    Heavy-Duty          -MMB    with Movable Mounting Brackets          -UR    Urinal Carrier          -VP    Vandal-Proof Trim          -WC    Water Cooler Carrier          -WCBL    Water Cooler Bi-Level Carrier          -10    Extension Sleeves or Hardware for Thicker Walls, See Product          -60    Valve Plate for Attaching to Upright          -66    Split Header for Stainless Steel Arms          -67    Concealed Arm Carrier for Wheelchair Lavatory          -75    2" Chrome Plated Escutcheons          -76    4" Chrome Plated Escutcheons          -77    6" Chrome Plated Escutcheons</p>																																													
LIST PRICE																																																					
TYPE NO.	17125	\$199.00																																																			
	<p align="center"><b>FLOOR-MOUNT ADJUSTABLE EXPOSED ARMS</b></p> <table border="1"> <thead> <tr> <th colspan="3">LIST PRICE</th> </tr> </thead> <tbody> <tr> <td>TYPE NO.</td> <td>17380</td> <td>17380-BB</td> </tr> <tr> <td></td> <td>\$616.00</td> <td>\$967.00</td> </tr> </tbody> </table> <p><b>ADD FOR OPTIONS:</b></p> <table border="1"> <thead> <tr> <th colspan="2">17380</th> <th colspan="2">17380-BB</th> </tr> </thead> <tbody> <tr> <td>-BB**</td> <td>\$351.00</td> <td>ABOVE</td> <td></td> </tr> <tr> <td>-HD</td> <td>73.00</td> <td>\$146.00</td> <td></td> </tr> <tr> <td>-VP</td> <td>57.00</td> <td>114.00</td> <td></td> </tr> <tr> <td>-10*</td> <td>21.00</td> <td>42.00</td> <td></td> </tr> <tr> <td>-60</td> <td>64.00</td> <td>128.00</td> <td></td> </tr> <tr> <td>-66**</td> <td>P.O.A.*</td> <td>P.O.A.*</td> <td></td> </tr> </tbody> </table> <p>* Hardware for Walls over 4-1/2", Specify Wall Thickness, Price Per Inch"          ** -66 cannot be Furnished with -BB.          • Price on Application</p>	LIST PRICE			TYPE NO.	17380	17380-BB		\$616.00	\$967.00	17380		17380-BB		-BB**	\$351.00	ABOVE		-HD	73.00	\$146.00		-VP	57.00	114.00		-10*	21.00	42.00		-60	64.00	128.00		-66**	P.O.A.*	P.O.A.*																
LIST PRICE																																																					
TYPE NO.	17380	17380-BB																																																			
	\$616.00	\$967.00																																																			
17380		17380-BB																																																			
-BB**	\$351.00	ABOVE																																																			
-HD	73.00	\$146.00																																																			
-VP	57.00	114.00																																																			
-10*	21.00	42.00																																																			
-60	64.00	128.00																																																			
-66**	P.O.A.*	P.O.A.*																																																			

	<b>FLOOR-MOUNT BEARING PLATE TYPE</b>																							
	<b>LIST PRICE</b>																							
	17560	17560-BB	17560-UR 17560-WC	17560-WCBL																				
	\$365.00	\$509.00	\$365.00	\$723.00																				
	<b>ADD FOR OPTIONS:</b> <table border="1" style="width: 100%; border-collapse: collapse;"> <thead> <tr> <th style="width: 30%;"></th> <th style="width: 35%; text-align: center;">17560</th> <th style="width: 35%; text-align: center;">17560-BB</th> </tr> </thead> <tbody> <tr> <td>-BB</td> <td style="text-align: center;">\$144.00</td> <td style="text-align: center;">ABOVE</td> </tr> <tr> <td>-UR**</td> <td style="text-align: center;">0.00</td> <td style="text-align: center;">----</td> </tr> <tr> <td>-WC**</td> <td style="text-align: center;">0.00</td> <td style="text-align: center;">----</td> </tr> <tr> <td>-WCBL**</td> <td style="text-align: center;">358.00</td> <td style="text-align: center;">----</td> </tr> <tr> <td>-10*</td> <td style="text-align: center;">21.00</td> <td style="text-align: center;">\$42.00</td> </tr> <tr> <td>-60</td> <td style="text-align: center;">64.00</td> <td style="text-align: center;">128.00</td> </tr> </tbody> </table>					17560	17560-BB	-BB	\$144.00	ABOVE	-UR**	0.00	----	-WC**	0.00	----	-WCBL**	358.00	----	-10*	21.00	\$42.00	-60	64.00
	17560	17560-BB																						
-BB	\$144.00	ABOVE																						
-UR**	0.00	----																						
-WC**	0.00	----																						
-WCBL**	358.00	----																						
-10*	21.00	\$42.00																						
-60	64.00	128.00																						
<p>* Hardware for Walls over 4", Specify Wall Thickness, Price Per Inch                  ** Cannot be Furnished with -60</p>																								

	<b>WALL-MOUNT HANGER PLATE TYPE</b>									
	<b>LIST PRICE</b>									
	17590	17590-DP	17590-UR							
	\$90.00	\$111.00	\$90.00							
	<b>ADD FOR OPTIONS:</b> <table border="1" style="width: 100%; border-collapse: collapse;"> <tbody> <tr> <td style="width: 30%;">-DP.....</td> <td style="width: 30%; text-align: center;">\$21.00</td> <td style="width: 30%;">-10*.....</td> <td style="width: 30%; text-align: center;">\$21.00</td> </tr> <tr> <td>-UR.....</td> <td style="text-align: center;">0.00</td> <td></td> <td></td> </tr> </tbody> </table>			-DP.....	\$21.00	-10*.....	\$21.00	-UR.....	0.00	
-DP.....	\$21.00	-10*.....	\$21.00							
-UR.....	0.00									
<p>* Hardware for Walls over 7", Specify Wall Thickness, Price Per Inch</p>										

	<b>FLOOR-MOUNT HEAVY-DUTY TYPE</b>										
	<b>LIST PRICE</b>										
	TYPE NO.	17720	\$1,109.00								
	<b>ADD FOR OPTIONS:</b> <table border="1" style="width: 100%; border-collapse: collapse;"> <tbody> <tr> <td style="width: 30%;">-VP.....</td> <td style="width: 30%; text-align: center;">\$57.00</td> <td style="width: 30%;">-66.....</td> <td style="width: 30%; text-align: center;">P.O.A. •</td> </tr> <tr> <td>-10*.....</td> <td style="text-align: center;">43.00</td> <td></td> <td></td> </tr> </tbody> </table>			-VP.....	\$57.00	-66.....	P.O.A. •	-10*.....	43.00		
	-VP.....	\$57.00	-66.....	P.O.A. •							
-10*.....	43.00										
<p>* Hardware for Walls over 4", Specify Wall Thickness, Price Per Inch                  • Price on Application</p>											

	<b>FLOOR-MOUNT WITH ADJUSTABLE COUPLING</b>										
	<b>LIST PRICE</b>										
	TYPE NO.	17730	\$522.00								
	<b>ADD FOR OPTIONS:</b> <table border="1" style="width: 100%; border-collapse: collapse;"> <tbody> <tr> <td style="width: 30%;">-VP.....</td> <td style="width: 30%; text-align: center;">\$57.00</td> <td style="width: 30%;">-60.....</td> <td style="width: 30%; text-align: center;">\$64.00</td> </tr> <tr> <td>-11.....</td> <td style="text-align: center;">0.00</td> <td></td> <td></td> </tr> </tbody> </table>			-VP.....	\$57.00	-60.....	\$64.00	-11.....	0.00		
	-VP.....	\$57.00	-60.....	\$64.00							
-11.....	0.00										

	<b>FLOOR-MOUNT WITH FITTING</b>										
	<b>LIST PRICE</b>										
	TYPE NO.	17735	\$865.00								
	<b>ADD FOR OPTIONS:</b> <table border="1" style="width: 100%; border-collapse: collapse;"> <tbody> <tr> <td style="width: 30%;">-VP.....</td> <td style="width: 30%; text-align: center;">\$57.00</td> <td style="width: 30%;">-45.....</td> <td style="width: 30%; text-align: center;">\$159.00</td> </tr> <tr> <td>-10*.....</td> <td style="text-align: center;">0.00</td> <td>-46.....</td> <td style="text-align: center;">159.00</td> </tr> </tbody> </table>			-VP.....	\$57.00	-45.....	\$159.00	-10*.....	0.00	-46.....	159.00
	-VP.....	\$57.00	-45.....	\$159.00							
-10*.....	0.00	-46.....	159.00								
<p>* Hardware for Walls over 5-3/8", Specify Wall Thickness, Price Per Inch  <b>NOTE:</b> Other Fittings Available on Request. Contact your Josam Representative.</p>											

### Fixture Carrier OPTION DESCRIPTIONS

- BB Back-to-Back Carrier
- DP Double Plate Carrier
- UR Urinal Carrier
- VP Vandal-Proof Trim
- WC Water Cooler Carrier
- WCBL Water Cooler Bi-Level Carrier
- 10 Hardware for Thicker Walls
- 11 Cast Iron Adjustable Extension through 12" Length, Specify 6", 9" or 12" on Order
- 45 Threaded High Left-Hand Auxiliary Vent
- 46 Threaded High Right-Hand Auxiliary Vent
- 60 Valve Plate for Attaching to Upright
- 66 Split Header for Stainless Steel Arms

<b>21500</b> 	<b>15" DOME, LARGE SUMP</b>				
	LIST PRICE				
PIPE SIZE	21500	21500-AE	21500-16	21500-AE-16	
2", 3", 4"	\$326.00	\$652.00	\$519.00	\$845.00	
5", 6"	466.00	792.00	659.00	985.00	
8"	605.00	931.00	N/A	N/A	
10"	954.00	1,280.00	N/A	N/A	
<b>ADD FOR OPTIONS:</b>					
-AE	\$326.00	-6	\$606.00	-23	\$382.00
-AER	150.00	-10**	305.00	-26	113.00
-IRMA	361.00	-10-20**	482.00	-33	231.00
-CR	192.00	-16	193.00	-VP	57.00
-1	112.00	-17	105.00	-66	170.00
-1C*	45.00	-19	361.00	-T	36.00
-2	125.00	-20	441.00	-X	0.00
-3	237.00	-21	190.00	-Y	0.00
-3C	170.00	-22	96.00	-Z	0.00
-4	86.00				
* Minimum Deck Opening 16.5" Dia. ** Specify Height, Price Each 4" or Fraction ◇ -16 and -17 cannot be furnished together					

<b>22010</b> 	<b>12" BEEHIVE DOME, MEDIUM SUMP</b>		
	LIST PRICE		
PIPE SIZE	2"-6"	\$288.00	
<b>ADD FOR OPTIONS:</b>			
-1	\$69.00	-10-20**	\$80.00
-1C*	45.00	-17	87.00
-2	118.00	-20	180.00
-3	187.00	-21	73.00
-3C	163.00	-23	187.00
-10**	40.00	-VP	52.00
-66	\$73.00	-T	36.00
-X	0.00	-Z	0.00
* Minimum Deck Opening 13.75" Dia. ** Specify Height, Price Per Inch			

<b>22080</b> 	<b>9" HIGH DOME, SMALL SUMP</b>		
	LIST PRICE		
PIPE SIZE	2", 3", 4"	\$243.00	
<b>ADD FOR OPTIONS:</b>			
-TSO	\$85.00	-3C	156.00
-1	69.00	-10**	\$40.00
-1C*	38.00	-10-20**	80.00
-2	118.00	-17	87.00
-3	187.00	-20	92.00
		-21	37.00
-23	153.00	-VP	52.00
◇ Cannot be used with Drain Receiver * Minimum Deck Opening 10.75" Dia. **Specify Height, Price Per Inch			

<b>22100</b> 	<b>COMBINATION DRAIN/OVERFLOW, SMALL SUMP</b>		
	LIST PRICE		
PIPE SIZE	2", 3", 4"	\$800.00	
<b>ADD FOR OPTIONS:</b>			
-10*	\$80.00	-28	\$0.00
-20	184.00	-33	129.00
-23	153.00	-VP	52.00
-IRMA	\$425.00	-Z	0.00
* Specify Height, Price Per Inch			

<b>22200</b>  <b>NEW</b>	<b>COMBINATION DRAIN/OVERFLOW, MEDIUM SUMP</b>		
	LIST PRICE		
PIPE SIZE	2"-6"	\$895.00	
<b>ADD FOR OPTIONS:</b>			
-10*	\$80.00	-33	\$430.00
-20	360.00	-VP	104.00
-23	374.00	-IRMA	576.00
-T	\$72.00	-X	0.00
-Z	0.00		
* Specify Height, Price Per Inch			

<b>22500</b>  <b>NEW</b>	<b>COMBINATION DRAIN/OVERFLOW, LARGE SUMP</b>		
	LIST PRICE		
PIPE SIZE	2", 3", 4"	5", 6"	8"
	\$1,146.00	\$1,425.00	\$1,704.00
<b>ADD FOR OPTIONS:</b>			
-10*	\$608.00	-VP	\$114.00
-20	882.00	-IRMA	726.00
-23	764.00	-T	72.00
-33	462.00	-X	0.00
* Specify Height, Price Each 4" or Fraction			

<b>23500</b> 	<b>14" PROMENADE TOP, LARGE SUMP</b>				
	LIST PRICE				
PIPE SIZE	23500	23500-AE	23500-6	23500-IRMA	
2", 3", 4"	\$554.00	\$880.00	\$1,160.00	\$915.00	
5", 6"	685.00	1,011.00	1,291.00	1,046.00	
8"	813.00	1,139.00	N/A	1,174.00	
10"	1,086.00	1,412.00	N/A	1,447.00	
<b>ADD FOR OPTIONS:</b>					
-AE	\$326.00	-6	\$606.00	-51	\$376.00
-IRMA	361.00	-10**	305.00	-PG	358.00
-CR	192.00	-10-20**	482.00	-VP	67.00
-1	112.00	-18	273.00	-66	170.00
-1C*	45.00	-20	409.00	-T	36.00
-2	125.00	-36	283.00	-X	0.00
-3	237.00	-37-50	746.00	-Y	0.00
-3C	170.00	-37-51	657.00	-Z	0.00
-4	86.00	-50	461.00		
* Minimum Deck Opening 16.5" Dia. ** Specify Height, Price Each 4" or Fraction					













## Roof Drain OPTION DESCRIPTIONS





- AE LEVELEZE® Adjustable Extension
- AER Adjustable Extension using Threaded Rods and Hardware
- CR Clamping Drain Receiver
- IRMA Perforated Stainless Steel Extension
- PG Parking Grate
- VP Vandal-Proof Dome or Grate
- 1 Deck Clamp Assembly
- 1C Drain Receiver Clips
- 2 Drain Receiver
- 3 Deck Clamp Assembly and Drain Receiver
- 3C Drain Receiver and Drain Receiver Clips
- 4 Secondary Flashing Clamp (use with -AE Only)
- 6 Extra Wide Flange Drain Body (2" through 6", -X Only)
- 10 Fixed Extended Collar, Cast Iron
- 10-20 Fixed Extended Collar, Galvanized
- 16 Internal Water Guard 2-6" Outlets Only
- 17 2" High Solid Clamping Collar
- 18 Extra Deep Sump
- 19 Clamp Collar w/Perforated SS Gravel Guard
- 20 Galvanized Cast Iron Parts
- 21 Galvanized Cast Iron Dome Only
- 22 Cast Iron Dome
- 23 Rough Bronze Dome
- 26 Aluminum Dome
- 28 Cast Iron Dome for Overflow Drain
- 33 Stainless Mesh Screen-Covered Dome
- 36 Ductile Iron Grate (Cast Iron Top Only)
- 37-50 HD Ductile Iron Undergrate Laminated Top, Satin Finish Nikaloy
- 37-51 HD Ductile Iron Undergrate Laminated Top, Satin Finish Bronze
- 50 C.I. Undergrate Laminated Top, Satin Finish Nikaloy
- 51 C.I. Undergrate Laminated Top, Satin Finish Bronze
- Outlets**
- 66 No-Hub Side Outlet, 2"-6"
- T Threaded Outlet
- TSO Threaded Side Outlet
- X Inside Caulk Outlet
- Y Hub Outlet w/Gasket, 2"-4"
- Z No-Hub Spigot Outlet







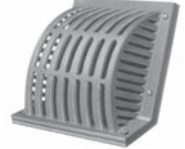













# ROOF DRAINS





















 <p><b>23510</b></p>	<p><b>15" EXTRA HEAVY-DUTY PARKING GRATE, LARGE SUMP</b></p> <table border="1"> <thead> <tr> <th colspan="4">LIST PRICE</th> </tr> <tr> <th>PIPE SIZE</th> <th>2", 3", 4"</th> <th>5", 6"</th> <th>8"</th> </tr> </thead> <tbody> <tr> <td></td> <td>\$719.00</td> <td>\$851.00</td> <td>\$1,016.00</td> </tr> </tbody> </table> <p><b>ADD FOR OPTIONS:</b></p> <table> <tr> <td>-CR.....</td> <td>\$192.00</td> <td>-10**.....</td> <td>\$326.00</td> <td>-VP.....</td> <td>\$66.00</td> </tr> <tr> <td>-1.....</td> <td>112.00</td> <td>-10-20**.....</td> <td>460.00</td> <td>-T.....</td> <td>36.00</td> </tr> <tr> <td>-1C*.....</td> <td>45.00</td> <td>-20.....</td> <td>409.00</td> <td>-X.....</td> <td>0.00</td> </tr> <tr> <td>-2.....</td> <td>125.00</td> <td>-36.....</td> <td>282.00</td> <td>-Y.....</td> <td>0.00</td> </tr> <tr> <td>-3.....</td> <td>237.00</td> <td>-50.....</td> <td>1,184.00</td> <td>-Z.....</td> <td>0.00</td> </tr> <tr> <td>-3C.....</td> <td>170.00</td> <td>-51.....</td> <td>1,063.00</td> <td></td> <td></td> </tr> </table> <p>* Minimum Deck Opening 16.5" Dia. ** Specify Height, Price Each 4" or Fraction</p>	LIST PRICE				PIPE SIZE	2", 3", 4"	5", 6"	8"		\$719.00	\$851.00	\$1,016.00	-CR.....	\$192.00	-10**.....	\$326.00	-VP.....	\$66.00	-1.....	112.00	-10-20**.....	460.00	-T.....	36.00	-1C*.....	45.00	-20.....	409.00	-X.....	0.00	-2.....	125.00	-36.....	282.00	-Y.....	0.00	-3.....	237.00	-50.....	1,184.00	-Z.....	0.00	-3C.....	170.00	-51.....	1,063.00			 <p><b>24030</b></p>	<p><b>13" SUPER-FLO® TOP, MEDIUM SUMP COMPOSITION DECK FLANGE</b></p> <table border="1"> <thead> <tr> <th colspan="3">LIST PRICE</th> </tr> <tr> <th>PIPE SIZE</th> <th>4", 5", 6", 8"</th> <th></th> </tr> </thead> <tbody> <tr> <td></td> <td></td> <td>\$819.00</td> </tr> </tbody> </table> <p><b>ADD FOR OPTIONS:</b></p> <table> <tr> <td>-1.....</td> <td>\$103.00</td> <td>-31.....</td> <td>\$52.00</td> <td>-VP.....</td> <td>\$68.00</td> </tr> <tr> <td>-20.....</td> <td>367.00</td> <td>-36.....</td> <td>121.00</td> <td>-X.....</td> <td>0.00</td> </tr> <tr> <td>-29.....</td> <td>111.00</td> <td>-50.....</td> <td>332.00</td> <td></td> <td></td> </tr> <tr> <td>-29-20.....</td> <td>203.00</td> <td>-51.....</td> <td>302.00</td> <td></td> <td></td> </tr> </table>	LIST PRICE			PIPE SIZE	4", 5", 6", 8"				\$819.00	-1.....	\$103.00	-31.....	\$52.00	-VP.....	\$68.00	-20.....	367.00	-36.....	121.00	-X.....	0.00	-29.....	111.00	-50.....	332.00			-29-20.....	203.00	-51.....	302.00		
LIST PRICE																																																																																				
PIPE SIZE	2", 3", 4"	5", 6"	8"																																																																																	
	\$719.00	\$851.00	\$1,016.00																																																																																	
-CR.....	\$192.00	-10**.....	\$326.00	-VP.....	\$66.00																																																																															
-1.....	112.00	-10-20**.....	460.00	-T.....	36.00																																																																															
-1C*.....	45.00	-20.....	409.00	-X.....	0.00																																																																															
-2.....	125.00	-36.....	282.00	-Y.....	0.00																																																																															
-3.....	237.00	-50.....	1,184.00	-Z.....	0.00																																																																															
-3C.....	170.00	-51.....	1,063.00																																																																																	
LIST PRICE																																																																																				
PIPE SIZE	4", 5", 6", 8"																																																																																			
		\$819.00																																																																																		
-1.....	\$103.00	-31.....	\$52.00	-VP.....	\$68.00																																																																															
-20.....	367.00	-36.....	121.00	-X.....	0.00																																																																															
-29.....	111.00	-50.....	332.00																																																																																	
-29-20.....	203.00	-51.....	302.00																																																																																	
 <p><b>23710</b></p>	<p><b>11" PROMENADE TOP, MEDIUM SUMP</b></p> <table border="1"> <thead> <tr> <th colspan="3">LIST PRICE</th> </tr> <tr> <th>PIPE SIZE</th> <th>2"-6"</th> <th></th> </tr> </thead> <tbody> <tr> <td></td> <td></td> <td>\$496.00</td> </tr> </tbody> </table> <p><b>ADD FOR OPTIONS:</b></p> <table> <tr> <td>-1.....</td> <td>\$69.00</td> <td>-12**.....</td> <td>\$40.00</td> <td>-66.....</td> <td>\$71.00</td> </tr> <tr> <td>-1C*.....</td> <td>45.00</td> <td>-20.....</td> <td>230.00</td> <td>-T.....</td> <td>36.00</td> </tr> <tr> <td>-2.....</td> <td>115.00</td> <td>-50.....</td> <td>339.00</td> <td>-X.....</td> <td>0.00</td> </tr> <tr> <td>-3.....</td> <td>184.00</td> <td>-51.....</td> <td>295.00</td> <td>-Z.....</td> <td>0.00</td> </tr> <tr> <td>-3C.....</td> <td>160.00</td> <td>-VP.....</td> <td>66.00</td> <td></td> <td></td> </tr> </table> <p>* Minimum Deck Opening 13.75" Dia. ** Specify Height, Price Per Inch</p>	LIST PRICE			PIPE SIZE	2"-6"				\$496.00	-1.....	\$69.00	-12**.....	\$40.00	-66.....	\$71.00	-1C*.....	45.00	-20.....	230.00	-T.....	36.00	-2.....	115.00	-50.....	339.00	-X.....	0.00	-3.....	184.00	-51.....	295.00	-Z.....	0.00	-3C.....	160.00	-VP.....	66.00			 <p><b>24040</b></p>	<p><b>9" SUPER-FLO® TOP, MEDIUM SUMP COMPOSITION DECK FLANGE</b></p> <table border="1"> <thead> <tr> <th colspan="3">LIST PRICE</th> </tr> <tr> <th>PIPE SIZE</th> <th>2", 3", 4"</th> <th></th> </tr> </thead> <tbody> <tr> <td></td> <td></td> <td>\$463.00</td> </tr> </tbody> </table> <p><b>ADD FOR OPTIONS:</b></p> <table> <tr> <td>-1.....</td> <td>\$69.00</td> <td>-31.....</td> <td>\$52.00</td> <td>-51.....</td> <td>\$190.00</td> </tr> <tr> <td>-20.....</td> <td>276.00</td> <td>-36.....</td> <td>96.00</td> <td>-VP.....</td> <td>68.00</td> </tr> <tr> <td>-29.....</td> <td>63.00</td> <td>-38..</td> <td>Deduct 41.00</td> <td>-X.....</td> <td>0.00</td> </tr> <tr> <td>-29-20.....</td> <td>95.00</td> <td>-50.....</td> <td>231.00</td> <td></td> <td></td> </tr> </table>	LIST PRICE			PIPE SIZE	2", 3", 4"				\$463.00	-1.....	\$69.00	-31.....	\$52.00	-51.....	\$190.00	-20.....	276.00	-36.....	96.00	-VP.....	68.00	-29.....	63.00	-38..	Deduct 41.00	-X.....	0.00	-29-20.....	95.00	-50.....	231.00											
LIST PRICE																																																																																				
PIPE SIZE	2"-6"																																																																																			
		\$496.00																																																																																		
-1.....	\$69.00	-12**.....	\$40.00	-66.....	\$71.00																																																																															
-1C*.....	45.00	-20.....	230.00	-T.....	36.00																																																																															
-2.....	115.00	-50.....	339.00	-X.....	0.00																																																																															
-3.....	184.00	-51.....	295.00	-Z.....	0.00																																																																															
-3C.....	160.00	-VP.....	66.00																																																																																	
LIST PRICE																																																																																				
PIPE SIZE	2", 3", 4"																																																																																			
		\$463.00																																																																																		
-1.....	\$69.00	-31.....	\$52.00	-51.....	\$190.00																																																																															
-20.....	276.00	-36.....	96.00	-VP.....	68.00																																																																															
-29.....	63.00	-38..	Deduct 41.00	-X.....	0.00																																																																															
-29-20.....	95.00	-50.....	231.00																																																																																	
 <p><b>23730</b></p>	<p><b>9" PROMENADE TOP, SMALL SUMP</b></p> <table border="1"> <thead> <tr> <th colspan="3">LIST PRICE</th> </tr> <tr> <th>PIPE SIZE</th> <th>2", 3", 4"</th> <th></th> </tr> </thead> <tbody> <tr> <td></td> <td></td> <td>\$377.00</td> </tr> </tbody> </table> <p><b>ADD FOR OPTIONS:</b></p> <table> <tr> <td>-TSO ◊.....</td> <td>\$85.00</td> <td>-12**.....</td> <td>\$40.00</td> <td>-T.....</td> <td>\$36.00</td> </tr> <tr> <td>-1.....</td> <td>69.00</td> <td>-12-20**.....</td> <td>80.00</td> <td>-X.....</td> <td>0.00</td> </tr> <tr> <td>-1C*.....</td> <td>38.00</td> <td>-20.....</td> <td>123.00</td> <td>-Y.....</td> <td>0.00</td> </tr> <tr> <td>-2.....</td> <td>115.00</td> <td>-50.....</td> <td>197.00</td> <td>-Z.....</td> <td>0.00</td> </tr> <tr> <td>-3.....</td> <td>184.00</td> <td>-51.....</td> <td>176.00</td> <td></td> <td></td> </tr> <tr> <td>-3C.....</td> <td>153.00</td> <td>-VP.....</td> <td>66.00</td> <td></td> <td></td> </tr> </table> <p>◊ Cannot be used with Drain Receiver * Minimum Deck Opening 10.25" Dia. ** Specify Height, Price Per Inch</p>	LIST PRICE			PIPE SIZE	2", 3", 4"				\$377.00	-TSO ◊.....	\$85.00	-12**.....	\$40.00	-T.....	\$36.00	-1.....	69.00	-12-20**.....	80.00	-X.....	0.00	-1C*.....	38.00	-20.....	123.00	-Y.....	0.00	-2.....	115.00	-50.....	197.00	-Z.....	0.00	-3.....	184.00	-51.....	176.00			-3C.....	153.00	-VP.....	66.00			 <p><b>24050</b></p>	<p><b>GARAGE DRAIN, 13" SPECIAL-DUTY TOP, WIDE FLANGE</b></p> <table border="1"> <thead> <tr> <th colspan="3">LIST PRICE</th> </tr> <tr> <th>PIPE SIZE</th> <th>5", 6"</th> <th>8"</th> </tr> </thead> <tbody> <tr> <td></td> <td>\$1,164.00</td> <td>\$1,301.00</td> </tr> </tbody> </table> <p><b>ADD FOR OPTIONS:</b></p> <table> <tr> <td>-1.....</td> <td>\$103.00</td> <td>-29-20.....</td> <td>\$205.00</td> <td>-51.....</td> <td>\$496.00</td> </tr> <tr> <td>-12*.....</td> <td>40.00</td> <td>-31.....</td> <td>52.00</td> <td>-VP.....</td> <td>68.00</td> </tr> <tr> <td>-20.....</td> <td>501.00</td> <td>-36.....</td> <td>121.00</td> <td>-X.....</td> <td>0.00</td> </tr> <tr> <td>-29.....</td> <td>95.00</td> <td>-50.....</td> <td>604.00</td> <td></td> <td></td> </tr> </table> <p>*Specify Height, Price Per Inch</p>	LIST PRICE			PIPE SIZE	5", 6"	8"		\$1,164.00	\$1,301.00	-1.....	\$103.00	-29-20.....	\$205.00	-51.....	\$496.00	-12*.....	40.00	-31.....	52.00	-VP.....	68.00	-20.....	501.00	-36.....	121.00	-X.....	0.00	-29.....	95.00	-50.....	604.00					
LIST PRICE																																																																																				
PIPE SIZE	2", 3", 4"																																																																																			
		\$377.00																																																																																		
-TSO ◊.....	\$85.00	-12**.....	\$40.00	-T.....	\$36.00																																																																															
-1.....	69.00	-12-20**.....	80.00	-X.....	0.00																																																																															
-1C*.....	38.00	-20.....	123.00	-Y.....	0.00																																																																															
-2.....	115.00	-50.....	197.00	-Z.....	0.00																																																																															
-3.....	184.00	-51.....	176.00																																																																																	
-3C.....	153.00	-VP.....	66.00																																																																																	
LIST PRICE																																																																																				
PIPE SIZE	5", 6"	8"																																																																																		
	\$1,164.00	\$1,301.00																																																																																		
-1.....	\$103.00	-29-20.....	\$205.00	-51.....	\$496.00																																																																															
-12*.....	40.00	-31.....	52.00	-VP.....	68.00																																																																															
-20.....	501.00	-36.....	121.00	-X.....	0.00																																																																															
-29.....	95.00	-50.....	604.00																																																																																	
 <p><b>23740</b></p>	<p><b>8" HEAVY-DUTY TOP, MEDIUM SUMP</b></p> <table border="1"> <thead> <tr> <th colspan="3">LIST PRICE</th> </tr> <tr> <th>PIPE SIZE</th> <th>2", 3", 4"</th> <th></th> </tr> </thead> <tbody> <tr> <td></td> <td></td> <td>\$959.00</td> </tr> </tbody> </table> <p><b>ADD FOR OPTIONS:</b></p> <table> <tr> <td>-TSO ◊.....</td> <td>\$85.00</td> <td>-3.....</td> <td>184.00</td> <td>-51..</td> <td>Deduct 46.00</td> </tr> <tr> <td>-1.....</td> <td>69.00</td> <td>-3C.....</td> <td>\$153.00</td> <td>-VP.....</td> <td>\$66.00</td> </tr> <tr> <td>-1C*.....</td> <td>38.00</td> <td>-12**.....</td> <td>48.00</td> <td>-T.....</td> <td>36.00</td> </tr> <tr> <td>-2.....</td> <td>115.00</td> <td>-12-20**.....</td> <td>74.00</td> <td>-X.....</td> <td>0.00</td> </tr> <tr> <td></td> <td></td> <td>-20.....</td> <td>131.00</td> <td>-Y.....</td> <td>0.00</td> </tr> </table> <p>◊ Cannot be used with Drain Receiver * Minimum Deck Opening 10.25" Dia. ** Specify Height, Price Per Inch</p>	LIST PRICE			PIPE SIZE	2", 3", 4"				\$959.00	-TSO ◊.....	\$85.00	-3.....	184.00	-51..	Deduct 46.00	-1.....	69.00	-3C.....	\$153.00	-VP.....	\$66.00	-1C*.....	38.00	-12**.....	48.00	-T.....	36.00	-2.....	115.00	-12-20**.....	74.00	-X.....	0.00			-20.....	131.00	-Y.....	0.00	 <p><b>24060</b></p>	<p><b>15" SPECIAL-DUTY TOP COMPOSITION DECK FLANGE</b></p> <table border="1"> <thead> <tr> <th colspan="3">LIST PRICE</th> </tr> <tr> <th>PIPE SIZE</th> <th>4", 6"</th> <th>8"</th> </tr> </thead> <tbody> <tr> <td></td> <td>\$1,452.00</td> <td>\$1,628.00</td> </tr> </tbody> </table> <p><b>ADD FOR OPTIONS:</b></p> <table> <tr> <td>-1.....</td> <td>\$111.00</td> <td>-29-20.....</td> <td>\$236.00</td> <td>-51.....</td> <td>\$360.00</td> </tr> <tr> <td>-20.....</td> <td>504.00</td> <td>-31.....</td> <td>121.00</td> <td>-VP.....</td> <td>68.00</td> </tr> <tr> <td>-29.....</td> <td>143.00</td> <td>-50.....</td> <td>416.00</td> <td>-X.....</td> <td>0.00</td> </tr> </table>	LIST PRICE			PIPE SIZE	4", 6"	8"		\$1,452.00	\$1,628.00	-1.....	\$111.00	-29-20.....	\$236.00	-51.....	\$360.00	-20.....	504.00	-31.....	121.00	-VP.....	68.00	-29.....	143.00	-50.....	416.00	-X.....	0.00															
LIST PRICE																																																																																				
PIPE SIZE	2", 3", 4"																																																																																			
		\$959.00																																																																																		
-TSO ◊.....	\$85.00	-3.....	184.00	-51..	Deduct 46.00																																																																															
-1.....	69.00	-3C.....	\$153.00	-VP.....	\$66.00																																																																															
-1C*.....	38.00	-12**.....	48.00	-T.....	36.00																																																																															
-2.....	115.00	-12-20**.....	74.00	-X.....	0.00																																																																															
		-20.....	131.00	-Y.....	0.00																																																																															
LIST PRICE																																																																																				
PIPE SIZE	4", 6"	8"																																																																																		
	\$1,452.00	\$1,628.00																																																																																		
-1.....	\$111.00	-29-20.....	\$236.00	-51.....	\$360.00																																																																															
-20.....	504.00	-31.....	121.00	-VP.....	68.00																																																																															
-29.....	143.00	-50.....	416.00	-X.....	0.00																																																																															
 <p><b>24020</b></p>	<p><b>9" SUPER-FLO® TOP, MEDIUM SUMP COMPOSITION DECK FLANGE</b></p> <table border="1"> <thead> <tr> <th colspan="3">LIST PRICE</th> </tr> <tr> <th>PIPE SIZE</th> <th>2", 3", 4"</th> <th></th> </tr> </thead> <tbody> <tr> <td></td> <td></td> <td>\$372.00</td> </tr> </tbody> </table> <p><b>ADD FOR OPTIONS:</b></p> <table> <tr> <td>-1.....</td> <td>\$69.00</td> <td>-31.....</td> <td>\$52.00</td> <td>-51.....</td> <td>\$148.00</td> </tr> <tr> <td>-20.....</td> <td>314.00</td> <td>-36.....</td> <td>97.00</td> <td>-VP.....</td> <td>68.00</td> </tr> <tr> <td>-29.....</td> <td>30.00</td> <td>-38..</td> <td>Deduct 41.00</td> <td>-X.....</td> <td>0.00</td> </tr> <tr> <td>-29-20.....</td> <td>66.00</td> <td>-50.....</td> <td>151.00</td> <td></td> <td></td> </tr> </table>	LIST PRICE			PIPE SIZE	2", 3", 4"				\$372.00	-1.....	\$69.00	-31.....	\$52.00	-51.....	\$148.00	-20.....	314.00	-36.....	97.00	-VP.....	68.00	-29.....	30.00	-38..	Deduct 41.00	-X.....	0.00	-29-20.....	66.00	-50.....	151.00			 <p><b>24200</b></p>	<p><b>16" PROMENADE TOP, ALL LEVEL BONDING FLANGE</b></p> <table border="1"> <thead> <tr> <th colspan="3">LIST PRICE</th> </tr> <tr> <th>PIPE SIZE</th> <th>2"-6"</th> <th></th> </tr> </thead> <tbody> <tr> <td></td> <td></td> <td>\$2,218.00</td> </tr> </tbody> </table> <p><b>ADD FOR OPTIONS:</b></p> <table> <tr> <td>-1.....</td> <td>\$111.00</td> <td>-50.....</td> <td>\$934.00</td> <td>-60-50..</td> <td>\$1,256.00</td> </tr> <tr> <td>-20.....</td> <td>441.00</td> <td>-51.....</td> <td>844.00</td> <td>-60-51....</td> <td>1,131.00</td> </tr> <tr> <td>-VP.....</td> <td>68.00</td> <td>-60.....</td> <td>102.00</td> <td>-X.....</td> <td>0.00</td> </tr> </table>	LIST PRICE			PIPE SIZE	2"-6"				\$2,218.00	-1.....	\$111.00	-50.....	\$934.00	-60-50..	\$1,256.00	-20.....	441.00	-51.....	844.00	-60-51....	1,131.00	-VP.....	68.00	-60.....	102.00	-X.....	0.00																					
LIST PRICE																																																																																				
PIPE SIZE	2", 3", 4"																																																																																			
		\$372.00																																																																																		
-1.....	\$69.00	-31.....	\$52.00	-51.....	\$148.00																																																																															
-20.....	314.00	-36.....	97.00	-VP.....	68.00																																																																															
-29.....	30.00	-38..	Deduct 41.00	-X.....	0.00																																																																															
-29-20.....	66.00	-50.....	151.00																																																																																	
LIST PRICE																																																																																				
PIPE SIZE	2"-6"																																																																																			
		\$2,218.00																																																																																		
-1.....	\$111.00	-50.....	\$934.00	-60-50..	\$1,256.00																																																																															
-20.....	441.00	-51.....	844.00	-60-51....	1,131.00																																																																															
-VP.....	68.00	-60.....	102.00	-X.....	0.00																																																																															
 <p><b>24500</b></p>	<p><b>9" SUPER-FLO® TOP, MEDIUM SUMP COMPOSITION DECK FLANGE</b></p> <table border="1"> <thead> <tr> <th colspan="3">LIST PRICE</th> </tr> <tr> <th>PIPE SIZE</th> <th>2", 3", 4"</th> <th></th> </tr> </thead> <tbody> <tr> <td></td> <td></td> <td>\$372.00</td> </tr> </tbody> </table> <p><b>ADD FOR OPTIONS:</b></p> <table> <tr> <td>-1.....</td> <td>\$69.00</td> <td>-31.....</td> <td>\$52.00</td> <td>-51.....</td> <td>\$148.00</td> </tr> <tr> <td>-20.....</td> <td>314.00</td> <td>-36.....</td> <td>97.00</td> <td>-VP.....</td> <td>68.00</td> </tr> <tr> <td>-29.....</td> <td>30.00</td> <td>-38..</td> <td>Deduct 41.00</td> <td>-X.....</td> <td>0.00</td> </tr> <tr> <td>-29-20.....</td> <td>66.00</td> <td>-50.....</td> <td>151.00</td> <td></td> <td></td> </tr> </table>	LIST PRICE			PIPE SIZE	2", 3", 4"				\$372.00	-1.....	\$69.00	-31.....	\$52.00	-51.....	\$148.00	-20.....	314.00	-36.....	97.00	-VP.....	68.00	-29.....	30.00	-38..	Deduct 41.00	-X.....	0.00	-29-20.....	66.00	-50.....	151.00			 <p><b>24500</b></p>	<p><b>SILL TYPE 4" DOME, SHALLOW SUMP</b></p> <table border="1"> <thead> <tr> <th colspan="4">LIST PRICE</th> </tr> <tr> <th>PIPE SIZE</th> <th>24500</th> <th>24500-45</th> <th>24500-90</th> </tr> </thead> <tbody> <tr> <td>2", 3"</td> <td>\$192.00</td> <td>\$244.00</td> <td>\$244.00</td> </tr> <tr> <td>4"</td> <td>279.00</td> <td>331.00</td> <td>331.00</td> </tr> </tbody> </table> <p><b>ADD FOR OPTIONS:</b></p> <table> <tr> <td>-45.....</td> <td>\$52.00</td> <td>-27.....</td> <td>\$37.00</td> <td>-51.....</td> <td>\$55.00</td> </tr> <tr> <td>-90.....</td> <td>52.00</td> <td>-33.....</td> <td>108.00</td> <td>-VP.....</td> <td>25.00</td> </tr> <tr> <td>-20.....</td> <td>74.00</td> <td>-35.....</td> <td>0.00</td> <td>-T.....</td> <td>0.00</td> </tr> <tr> <td>-24.....</td> <td>40.00</td> <td>-50.....</td> <td>94.00</td> <td></td> <td></td> </tr> </table>	LIST PRICE				PIPE SIZE	24500	24500-45	24500-90	2", 3"	\$192.00	\$244.00	\$244.00	4"	279.00	331.00	331.00	-45.....	\$52.00	-27.....	\$37.00	-51.....	\$55.00	-90.....	52.00	-33.....	108.00	-VP.....	25.00	-20.....	74.00	-35.....	0.00	-T.....	0.00	-24.....	40.00	-50.....	94.00										
LIST PRICE																																																																																				
PIPE SIZE	2", 3", 4"																																																																																			
		\$372.00																																																																																		
-1.....	\$69.00	-31.....	\$52.00	-51.....	\$148.00																																																																															
-20.....	314.00	-36.....	97.00	-VP.....	68.00																																																																															
-29.....	30.00	-38..	Deduct 41.00	-X.....	0.00																																																																															
-29-20.....	66.00	-50.....	151.00																																																																																	
LIST PRICE																																																																																				
PIPE SIZE	24500	24500-45	24500-90																																																																																	
2", 3"	\$192.00	\$244.00	\$244.00																																																																																	
4"	279.00	331.00	331.00																																																																																	
-45.....	\$52.00	-27.....	\$37.00	-51.....	\$55.00																																																																															
-90.....	52.00	-33.....	108.00	-VP.....	25.00																																																																															
-20.....	74.00	-35.....	0.00	-T.....	0.00																																																																															
-24.....	40.00	-50.....	94.00																																																																																	

 <p><b>24700</b></p>	<p><b>PARAPET TYPE, SLOPING GRATE</b></p> <table border="1"> <thead> <tr> <th colspan="3">LIST PRICE</th> </tr> <tr> <th>PIPE SIZE</th> <th>2", 3", 4"</th> <th>5", 6"</th> </tr> </thead> <tbody> <tr> <td></td> <td>\$482.00</td> <td>\$875.00</td> </tr> </tbody> </table> <p><b>ADD FOR OPTIONS:</b></p> <table> <tr> <td>-45 .....</td> <td>\$0.00</td> <td>-50 .....</td> <td>\$269.00</td> </tr> <tr> <td>-20 (2"-4") .....</td> <td>110.00</td> <td>-51 .....</td> <td>150.00</td> </tr> <tr> <td>-20 (5"-6") .....</td> <td>220.00</td> <td>-61 (2"-4") .....</td> <td>155.00</td> </tr> <tr> <td>-22 (2"-4") .....</td> <td>Deduct 196.00</td> <td>-61 (5"-6") .....</td> <td>260.00</td> </tr> <tr> <td>-22 (5"-6") .....</td> <td>Deduct 196.00</td> <td>-61-20 (2"-4") .....</td> <td>222.00</td> </tr> <tr> <td>-24 .....</td> <td>205.00</td> <td>-61-20 (5"-6") .....</td> <td>289.00</td> </tr> </table>	LIST PRICE			PIPE SIZE	2", 3", 4"	5", 6"		\$482.00	\$875.00	-45 .....	\$0.00	-50 .....	\$269.00	-20 (2"-4") .....	110.00	-51 .....	150.00	-20 (5"-6") .....	220.00	-61 (2"-4") .....	155.00	-22 (2"-4") .....	Deduct 196.00	-61 (5"-6") .....	260.00	-22 (5"-6") .....	Deduct 196.00	-61-20 (2"-4") .....	222.00	-24 .....	205.00	-61-20 (5"-6") .....	289.00	 <p><b>25500</b></p>	<p><b>FLO-SEPTOR®, LARGE SUMP</b></p> <table border="1"> <thead> <tr> <th colspan="3">LIST PRICE</th> </tr> <tr> <th>PIPE SIZE</th> <th>2", 3", 4"</th> <th>5", 6"</th> </tr> </thead> <tbody> <tr> <td></td> <td>\$431.00</td> <td>\$578.00</td> </tr> </tbody> </table> <p><b>ADD FOR OPTIONS:</b></p> <table> <tr> <td>-CR .....</td> <td>\$131.00</td> <td>-20 .....</td> <td>\$409.00</td> <td>-Y .....</td> <td>\$0.00</td> </tr> <tr> <td>-1 .....</td> <td>112.00</td> <td>-66 .....</td> <td>170.00</td> <td>-Z .....</td> <td>0.00</td> </tr> <tr> <td>-2 .....</td> <td>125.00</td> <td>-T .....</td> <td>36.00</td> <td></td> <td></td> </tr> <tr> <td>-3 .....</td> <td>237.00</td> <td>-X .....</td> <td>0.00</td> <td></td> <td></td> </tr> </table>	LIST PRICE			PIPE SIZE	2", 3", 4"	5", 6"		\$431.00	\$578.00	-CR .....	\$131.00	-20 .....	\$409.00	-Y .....	\$0.00	-1 .....	112.00	-66 .....	170.00	-Z .....	0.00	-2 .....	125.00	-T .....	36.00			-3 .....	237.00	-X .....	0.00		
LIST PRICE																																																																					
PIPE SIZE	2", 3", 4"	5", 6"																																																																			
	\$482.00	\$875.00																																																																			
-45 .....	\$0.00	-50 .....	\$269.00																																																																		
-20 (2"-4") .....	110.00	-51 .....	150.00																																																																		
-20 (5"-6") .....	220.00	-61 (2"-4") .....	155.00																																																																		
-22 (2"-4") .....	Deduct 196.00	-61 (5"-6") .....	260.00																																																																		
-22 (5"-6") .....	Deduct 196.00	-61-20 (2"-4") .....	222.00																																																																		
-24 .....	205.00	-61-20 (5"-6") .....	289.00																																																																		
LIST PRICE																																																																					
PIPE SIZE	2", 3", 4"	5", 6"																																																																			
	\$431.00	\$578.00																																																																			
-CR .....	\$131.00	-20 .....	\$409.00	-Y .....	\$0.00																																																																
-1 .....	112.00	-66 .....	170.00	-Z .....	0.00																																																																
-2 .....	125.00	-T .....	36.00																																																																		
-3 .....	237.00	-X .....	0.00																																																																		
 <p><b>24720</b></p>	<p><b>PARAPET TYPE, ANGLE GRATE</b></p> <table border="1"> <thead> <tr> <th colspan="3">LIST PRICE</th> </tr> <tr> <th>PIPE SIZE</th> <th>24720</th> <th>24720-45</th> </tr> </thead> <tbody> <tr> <td>2", 3", 4"</td> <td>\$305.00</td> <td>\$305.00</td> </tr> <tr> <td>5", 6"</td> <td>579.00</td> <td>579.00</td> </tr> </tbody> </table> <p><b>ADD FOR OPTIONS:</b></p> <table> <tr> <td>-45 .....</td> <td>\$0.00</td> <td>-50 .....</td> <td>\$466.00</td> </tr> <tr> <td>-20 (2"-4") .....</td> <td>110.00</td> <td>-51 .....</td> <td>347.00</td> </tr> <tr> <td>-20 (5"-6") .....</td> <td>220.00</td> <td>-61 (2"-4") .....</td> <td>155.00</td> </tr> <tr> <td>-23 (2"-4") .....</td> <td>197.00</td> <td>-61 (5"-6") .....</td> <td>260.00</td> </tr> <tr> <td>-23 (5"-6") .....</td> <td>321.00</td> <td>-61-20 (2"-4") .....</td> <td>222.00</td> </tr> <tr> <td>-24 (2"-4") .....</td> <td>411.00</td> <td>-61-20 (5"-6") .....</td> <td>289.00</td> </tr> <tr> <td>-24 (5"-6") .....</td> <td>671.00</td> <td>-VP .....</td> <td>25.00</td> </tr> </table>	LIST PRICE			PIPE SIZE	24720	24720-45	2", 3", 4"	\$305.00	\$305.00	5", 6"	579.00	579.00	-45 .....	\$0.00	-50 .....	\$466.00	-20 (2"-4") .....	110.00	-51 .....	347.00	-20 (5"-6") .....	220.00	-61 (2"-4") .....	155.00	-23 (2"-4") .....	197.00	-61 (5"-6") .....	260.00	-23 (5"-6") .....	321.00	-61-20 (2"-4") .....	222.00	-24 (2"-4") .....	411.00	-61-20 (5"-6") .....	289.00	-24 (5"-6") .....	671.00	-VP .....	25.00	<p><b>OPTION DESCRIPTIONS</b></p> <ul style="list-style-type: none"> <li>-BS Bird Screen</li> <li>-CR Clamping Drain Receiver</li> <li>-VP Vandal-Proof Dome</li> <li>-1 Deck Clamp Assembly</li> <li>-1C Drain Receiver Clips</li> <li>-2 Drain Receiver</li> <li>-3 Deck Clamp Assembly and Drain Receiver</li> <li>-3C Drain Receiver and Drain Receiver Clips</li> <li>-10 Fixed Extension Collar, Cast Iron</li> <li>-10-20 Fixed Extension Collar, Galvanized</li> <li>-12 Extended Flashing Collar, Cast Iron</li> <li>-12-20 Extended Flashing Collar, Galvanized</li> <li>-20 Galvanized Cast Iron Parts</li> <li>-22 Cast Iron Grate</li> <li>-23 Rough Bronze Grate</li> <li>-24 Rough Nikaloy Dome or Grate</li> <li>-27 High Dome</li> <li>-29 Sediment Bucket, Cast Iron</li> <li>-29-20 Sediment Bucket, Galvanized</li> <li>-31 Chain Anchored Grate</li> <li>-33 Stainless Mesh Screen-Covered Dome</li> <li>-35 Flat Grate</li> <li>-36 Ductile Iron Grate (Cast Iron Top Only)</li> <li>-38 Less Grate</li> <li>-50 C.I. Undergrate Laminated Top, Satin Finish Nikaloy</li> <li>-51 C.I. Undergrate Laminated Top, Satin Finish Bronze</li> <li>-60 Square Top, Cast Iron</li> <li>-60-50 Square Top, Satin Finish Nikaloy</li> <li>-60-51 Square Top, Satin Finish Bronze</li> <li>-61 Downspout Elbow, Cast Iron</li> <li>-61-20 Downspout Elbow, Galvanized</li> <li>-62 Ornamental Gargoyle, Cast Iron</li> <li>-62-20 Ornamental Gargoyle, Galvanized</li> </ul> <p><b>Outlets</b></p> <ul style="list-style-type: none"> <li>-45 Body with 45 Degree Threaded Outlet</li> <li>-66 No-Hub Side Outlet, 2" - 6"</li> <li>-90 Body with 90 Degree Threaded Outlet</li> <li>-T Threaded Outlet</li> <li>-TSO Threaded Side Outlet</li> <li>-X Inside Caulk Outlet</li> <li>-Y Hub Outlet with Gasket, 2" - 4"</li> <li>-Z No-Hub Spigot Outlet</li> </ul>																											
LIST PRICE																																																																					
PIPE SIZE	24720	24720-45																																																																			
2", 3", 4"	\$305.00	\$305.00																																																																			
5", 6"	579.00	579.00																																																																			
-45 .....	\$0.00	-50 .....	\$466.00																																																																		
-20 (2"-4") .....	110.00	-51 .....	347.00																																																																		
-20 (5"-6") .....	220.00	-61 (2"-4") .....	155.00																																																																		
-23 (2"-4") .....	197.00	-61 (5"-6") .....	260.00																																																																		
-23 (5"-6") .....	321.00	-61-20 (2"-4") .....	222.00																																																																		
-24 (2"-4") .....	411.00	-61-20 (5"-6") .....	289.00																																																																		
-24 (5"-6") .....	671.00	-VP .....	25.00																																																																		
 <p><b>24900</b></p>	<p><b>PARAPET TYPE, ANGLE DOME GRATE</b></p> <table border="1"> <thead> <tr> <th colspan="3">LIST PRICE</th> </tr> <tr> <th>PIPE SIZE</th> <th>2"-6"</th> <th></th> </tr> </thead> <tbody> <tr> <td></td> <td></td> <td>\$1,728.00</td> </tr> </tbody> </table> <p><b>ADD FOR OPTIONS:</b></p> <table> <tr> <td>-20 .....</td> <td>\$245.00</td> <td>-61 (5"-6") .....</td> <td>\$260.00</td> </tr> <tr> <td>-24 .....</td> <td>269.00</td> <td>-61-20 (2"-4") .....</td> <td>222.00</td> </tr> <tr> <td>-50 .....</td> <td>351.00</td> <td>-61-20 (5"-6") .....</td> <td>289.00</td> </tr> <tr> <td>-51 .....</td> <td>248.00</td> <td>-VP .....</td> <td>28.00</td> </tr> <tr> <td>-61 (2"-4") .....</td> <td>155.00</td> <td></td> <td></td> </tr> </table>	LIST PRICE			PIPE SIZE	2"-6"				\$1,728.00	-20 .....	\$245.00	-61 (5"-6") .....	\$260.00	-24 .....	269.00	-61-20 (2"-4") .....	222.00	-50 .....	351.00	-61-20 (5"-6") .....	289.00	-51 .....	248.00	-VP .....	28.00	-61 (2"-4") .....	155.00																																									
LIST PRICE																																																																					
PIPE SIZE	2"-6"																																																																				
		\$1,728.00																																																																			
-20 .....	\$245.00	-61 (5"-6") .....	\$260.00																																																																		
-24 .....	269.00	-61-20 (2"-4") .....	222.00																																																																		
-50 .....	351.00	-61-20 (5"-6") .....	289.00																																																																		
-51 .....	248.00	-VP .....	28.00																																																																		
-61 (2"-4") .....	155.00																																																																				
 <p><b>25000</b></p>	<p><b>PARAPET SCUPPER SLEEVE</b></p> <table border="1"> <thead> <tr> <th colspan="5">LIST PRICE</th> </tr> <tr> <th>Wall Thickness</th> <th>9"</th> <th>13"</th> <th>17"</th> <th>21"</th> </tr> </thead> <tbody> <tr> <td></td> <td>\$431.00</td> <td>\$489.00</td> <td>\$605.00</td> <td>\$645.00</td> </tr> </tbody> </table> <p><b>ADD FOR OPTIONS:</b></p> <table> <tr> <td>-20 .....</td> <td>\$109.00</td> <td>-62 .....</td> <td>\$1,055.00</td> <td>-62-20 .....</td> <td>\$1,387.00</td> </tr> </table>	LIST PRICE					Wall Thickness	9"	13"	17"	21"		\$431.00	\$489.00	\$605.00	\$645.00	-20 .....	\$109.00	-62 .....	\$1,055.00	-62-20 .....	\$1,387.00																																															
LIST PRICE																																																																					
Wall Thickness	9"	13"	17"	21"																																																																	
	\$431.00	\$489.00	\$605.00	\$645.00																																																																	
-20 .....	\$109.00	-62 .....	\$1,055.00	-62-20 .....	\$1,387.00																																																																
 <p><b>25010</b></p>	<p><b>DOWNSPOUT NOZZLE</b></p> <table border="1"> <thead> <tr> <th colspan="6">LIST PRICE</th> </tr> <tr> <th>PIPE SIZE</th> <th>2", 3", 4"</th> <th>5", 6"</th> <th>8"</th> <th>10"</th> <th>*12"</th> </tr> </thead> <tbody> <tr> <td></td> <td>\$288.00</td> <td>\$685.00</td> <td>\$1,042.00</td> <td>\$1,352.00</td> <td>\$2,008.00</td> </tr> </tbody> </table> <p><b>ADD FOR OPTIONS:</b></p> <table> <tr> <td>-24 (2"-6") .....</td> <td>\$209.00</td> <td>-51 (10") .....</td> <td>\$179.00</td> </tr> <tr> <td>-24 (8") .....</td> <td>184.00</td> <td>-BS .....</td> <td>253.00</td> </tr> <tr> <td>-24 (10") .....</td> <td>246.00</td> <td>-T .....</td> <td>0.00</td> </tr> <tr> <td>-51 (2"-6") .....</td> <td>131.00</td> <td>-Z (Bronze Only) .....</td> <td>0.00</td> </tr> <tr> <td>-51 (8") .....</td> <td>138.00</td> <td></td> <td></td> </tr> </table> <p>*12" Size No-Hub Only</p>	LIST PRICE						PIPE SIZE	2", 3", 4"	5", 6"	8"	10"	*12"		\$288.00	\$685.00	\$1,042.00	\$1,352.00	\$2,008.00	-24 (2"-6") .....	\$209.00	-51 (10") .....	\$179.00	-24 (8") .....	184.00	-BS .....	253.00	-24 (10") .....	246.00	-T .....	0.00	-51 (2"-6") .....	131.00	-Z (Bronze Only) .....	0.00	-51 (8") .....	138.00																																
LIST PRICE																																																																					
PIPE SIZE	2", 3", 4"	5", 6"	8"	10"	*12"																																																																
	\$288.00	\$685.00	\$1,042.00	\$1,352.00	\$2,008.00																																																																
-24 (2"-6") .....	\$209.00	-51 (10") .....	\$179.00																																																																		
-24 (8") .....	184.00	-BS .....	253.00																																																																		
-24 (10") .....	246.00	-T .....	0.00																																																																		
-51 (2"-6") .....	131.00	-Z (Bronze Only) .....	0.00																																																																		
-51 (8") .....	138.00																																																																				

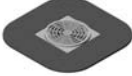
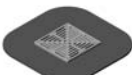
	<p><b>FLO-SEPTOR®, MEDIUM SUMP</b></p> <table border="1"> <thead> <tr> <th colspan="3">LIST PRICE</th> </tr> <tr> <th>PIPE SIZE</th> <th>2" - 6"</th> <th>\$332.00</th> </tr> </thead> <tbody> <tr> <td colspan="3"><b>ADD FOR OPTIONS:</b></td> </tr> <tr> <td>-1 .....</td> <td>\$69.00</td> <td>-20 .....</td> <td>\$90.00</td> <td>-X .....</td> <td>\$0.00</td> </tr> <tr> <td>-2 .....</td> <td>118.00</td> <td>-66 .....</td> <td>71.00</td> <td>-Z .....</td> <td>0.00</td> </tr> <tr> <td>-3 .....</td> <td>187.00</td> <td>-T .....</td> <td>36.00</td> <td></td> <td></td> </tr> </tbody> </table>	LIST PRICE			PIPE SIZE	2" - 6"	\$332.00	<b>ADD FOR OPTIONS:</b>			-1 .....	\$69.00	-20 .....	\$90.00	-X .....	\$0.00	-2 .....	118.00	-66 .....	71.00	-Z .....	0.00	-3 .....	187.00	-T .....	36.00				<p><b>FLO-SET®, 15" DOME, LARGE SUMP</b></p> <table border="1"> <thead> <tr> <th colspan="3">LIST PRICE</th> </tr> <tr> <th>PIPE SIZE</th> <th>28600</th> <th>28600-AE</th> </tr> </thead> <tbody> <tr> <td>2", 3", 4" 5", 6"</td> <td>\$865.00 1,004.00</td> <td>\$1,191.00 1,330.00</td> </tr> <tr> <td colspan="3"><b>ADD FOR OPTIONS:</b></td> </tr> <tr> <td>-AE .....</td> <td>\$326.00</td> <td>-3C .....</td> <td>\$170.00</td> <td>-VP .....</td> <td>\$57.00</td> </tr> <tr> <td>-CR .....</td> <td>192.00</td> <td>-4 .....</td> <td>86.00</td> <td>-66 .....</td> <td>170.00</td> </tr> <tr> <td>-1 .....</td> <td>112.00</td> <td>-10** .....</td> <td>305.00</td> <td>-T .....</td> <td>36.00</td> </tr> <tr> <td>-1C* .....</td> <td>45.00</td> <td>-10-20** .....</td> <td>482.00</td> <td>-X .....</td> <td>0.00</td> </tr> <tr> <td>-2 .....</td> <td>125.00</td> <td>-20 .....</td> <td>409.00</td> <td>-Y .....</td> <td>0.00</td> </tr> <tr> <td>-3 .....</td> <td>237.00</td> <td>-23 .....</td> <td>382.00</td> <td>-Z .....</td> <td>0.00</td> </tr> </tbody> </table> <p>* Minimum Deck Opening 16.5" Dia. ** Specify Height, Price Each 4" or Fraction</p>	LIST PRICE			PIPE SIZE	28600	28600-AE	2", 3", 4" 5", 6"	\$865.00 1,004.00	\$1,191.00 1,330.00	<b>ADD FOR OPTIONS:</b>			-AE .....	\$326.00	-3C .....	\$170.00	-VP .....	\$57.00	-CR .....	192.00	-4 .....	86.00	-66 .....	170.00	-1 .....	112.00	-10** .....	305.00	-T .....	36.00	-1C* .....	45.00	-10-20** .....	482.00	-X .....	0.00	-2 .....	125.00	-20 .....	409.00	-Y .....	0.00	-3 .....	237.00	-23 .....	382.00	-Z .....	0.00
LIST PRICE																																																																														
PIPE SIZE	2" - 6"	\$332.00																																																																												
<b>ADD FOR OPTIONS:</b>																																																																														
-1 .....	\$69.00	-20 .....	\$90.00	-X .....	\$0.00																																																																									
-2 .....	118.00	-66 .....	71.00	-Z .....	0.00																																																																									
-3 .....	187.00	-T .....	36.00																																																																											
LIST PRICE																																																																														
PIPE SIZE	28600	28600-AE																																																																												
2", 3", 4" 5", 6"	\$865.00 1,004.00	\$1,191.00 1,330.00																																																																												
<b>ADD FOR OPTIONS:</b>																																																																														
-AE .....	\$326.00	-3C .....	\$170.00	-VP .....	\$57.00																																																																									
-CR .....	192.00	-4 .....	86.00	-66 .....	170.00																																																																									
-1 .....	112.00	-10** .....	305.00	-T .....	36.00																																																																									
-1C* .....	45.00	-10-20** .....	482.00	-X .....	0.00																																																																									
-2 .....	125.00	-20 .....	409.00	-Y .....	0.00																																																																									
-3 .....	237.00	-23 .....	382.00	-Z .....	0.00																																																																									
	<p><b>FLO-SEPTOR®, SMALL SUMP</b></p> <table border="1"> <thead> <tr> <th colspan="3">LIST PRICE</th> </tr> <tr> <th>PIPE SIZE</th> <th>2", 3", 4"</th> <th>\$271.00</th> </tr> </thead> <tbody> <tr> <td colspan="3"><b>ADD FOR OPTIONS:</b></td> </tr> <tr> <td>TSO* .....</td> <td>\$100.00</td> <td>-3 .....</td> <td>\$187.00</td> <td>-X .....</td> <td>\$0.00</td> </tr> <tr> <td>-1 .....</td> <td>69.00</td> <td>-20 .....</td> <td>90.00</td> <td>-Y .....</td> <td>0.00</td> </tr> <tr> <td>-2 .....</td> <td>118.00</td> <td>-T .....</td> <td>36.00</td> <td>-Z .....</td> <td>0.00</td> </tr> </tbody> </table> <p>*Cannot be used with Drain Receiver</p>	LIST PRICE			PIPE SIZE	2", 3", 4"	\$271.00	<b>ADD FOR OPTIONS:</b>			TSO* .....	\$100.00	-3 .....	\$187.00	-X .....	\$0.00	-1 .....	69.00	-20 .....	90.00	-Y .....	0.00	-2 .....	118.00	-T .....	36.00	-Z .....	0.00		<p><b>ISOLATION DECK DRAIN</b></p> <table border="1"> <thead> <tr> <th colspan="4">LIST PRICE</th> </tr> <tr> <th>PIPE SIZE</th> <th>2", 3", 4"</th> <th>5", 6"</th> <th>8"</th> </tr> </thead> <tbody> <tr> <td></td> <td>\$326.00</td> <td>\$463.00</td> <td>\$605.00</td> </tr> <tr> <td colspan="4"><b>ADD FOR OPTIONS:</b></td> </tr> <tr> <td>-CR .....</td> <td>\$192.00</td> <td>-3C .....</td> <td>\$170.00</td> <td>-X .....</td> <td>\$0.00</td> </tr> <tr> <td>-1 .....</td> <td>112.00</td> <td>-17 .....</td> <td>105.00</td> <td>-Y .....</td> <td>0.00</td> </tr> <tr> <td>-1C* .....</td> <td>45.00</td> <td>-20 .....</td> <td>377.00</td> <td>-Z .....</td> <td>0.00</td> </tr> <tr> <td>-2 .....</td> <td>125.00</td> <td>-66 .....</td> <td>170.00</td> <td></td> <td></td> </tr> <tr> <td>-3 .....</td> <td>237.00</td> <td>-T .....</td> <td>36.00</td> <td></td> <td></td> </tr> </tbody> </table> <p>* Minimum Deck Opening 16.5" Dia.</p>	LIST PRICE				PIPE SIZE	2", 3", 4"	5", 6"	8"		\$326.00	\$463.00	\$605.00	<b>ADD FOR OPTIONS:</b>				-CR .....	\$192.00	-3C .....	\$170.00	-X .....	\$0.00	-1 .....	112.00	-17 .....	105.00	-Y .....	0.00	-1C* .....	45.00	-20 .....	377.00	-Z .....	0.00	-2 .....	125.00	-66 .....	170.00			-3 .....	237.00	-T .....	36.00				
LIST PRICE																																																																														
PIPE SIZE	2", 3", 4"	\$271.00																																																																												
<b>ADD FOR OPTIONS:</b>																																																																														
TSO* .....	\$100.00	-3 .....	\$187.00	-X .....	\$0.00																																																																									
-1 .....	69.00	-20 .....	90.00	-Y .....	0.00																																																																									
-2 .....	118.00	-T .....	36.00	-Z .....	0.00																																																																									
LIST PRICE																																																																														
PIPE SIZE	2", 3", 4"	5", 6"	8"																																																																											
	\$326.00	\$463.00	\$605.00																																																																											
<b>ADD FOR OPTIONS:</b>																																																																														
-CR .....	\$192.00	-3C .....	\$170.00	-X .....	\$0.00																																																																									
-1 .....	112.00	-17 .....	105.00	-Y .....	0.00																																																																									
-1C* .....	45.00	-20 .....	377.00	-Z .....	0.00																																																																									
-2 .....	125.00	-66 .....	170.00																																																																											
-3 .....	237.00	-T .....	36.00																																																																											
	<p><b>EXPANSION JOINT</b></p> <table border="1"> <thead> <tr> <th colspan="5">LIST PRICE</th> </tr> <tr> <th>PIPE SIZE</th> <th>2"</th> <th>3"</th> <th>4"</th> <th>5"</th> </tr> </thead> <tbody> <tr> <td></td> <td>\$305.00</td> <td>\$326.00</td> <td>\$367.00</td> <td>\$534.00</td> </tr> <tr> <th>PIPE SIZE</th> <th>6"</th> <th>8"</th> <th>10"</th> <td></td> </tr> <tr> <td></td> <td>\$612.00</td> <td>\$1,081.00</td> <td>\$2,250.00</td> <td></td> </tr> <tr> <td colspan="5"><b>ADD FOR OPTIONS:</b></td> </tr> <tr> <td>-20 .....</td> <td colspan="4">\$81.00</td> </tr> </tbody> </table>	LIST PRICE					PIPE SIZE	2"	3"	4"	5"		\$305.00	\$326.00	\$367.00	\$534.00	PIPE SIZE	6"	8"	10"			\$612.00	\$1,081.00	\$2,250.00		<b>ADD FOR OPTIONS:</b>					-20 .....	\$81.00					<p><b>16" DOME, EXTRA LARGE SUMP</b></p> <table border="1"> <thead> <tr> <th colspan="3">LIST PRICE</th> </tr> <tr> <th>PIPE SIZE</th> <th>12"</th> <th>\$1,083.00</th> </tr> </thead> <tbody> <tr> <td colspan="3"><b>ADD FOR OPTIONS:</b></td> </tr> <tr> <td>-1 .....</td> <td>\$221.00</td> <td>-10* .....</td> <td>\$455.00</td> <td>-20 .....</td> <td>\$656.00</td> </tr> <tr> <td>-2 .....</td> <td>248.00</td> <td>-10-20* .....</td> <td>717.00</td> <td>-VP .....</td> <td>57.00</td> </tr> <tr> <td>-3 .....</td> <td>469.00</td> <td>-17 .....</td> <td>314.00</td> <td>-Z .....</td> <td>0.00</td> </tr> </tbody> </table> <p>* Specify Height, Price Each 4" or Fraction</p>	LIST PRICE			PIPE SIZE	12"	\$1,083.00	<b>ADD FOR OPTIONS:</b>			-1 .....	\$221.00	-10* .....	\$455.00	-20 .....	\$656.00	-2 .....	248.00	-10-20* .....	717.00	-VP .....	57.00	-3 .....	469.00	-17 .....	314.00	-Z .....	0.00													
LIST PRICE																																																																														
PIPE SIZE	2"	3"	4"	5"																																																																										
	\$305.00	\$326.00	\$367.00	\$534.00																																																																										
PIPE SIZE	6"	8"	10"																																																																											
	\$612.00	\$1,081.00	\$2,250.00																																																																											
<b>ADD FOR OPTIONS:</b>																																																																														
-20 .....	\$81.00																																																																													
LIST PRICE																																																																														
PIPE SIZE	12"	\$1,083.00																																																																												
<b>ADD FOR OPTIONS:</b>																																																																														
-1 .....	\$221.00	-10* .....	\$455.00	-20 .....	\$656.00																																																																									
-2 .....	248.00	-10-20* .....	717.00	-VP .....	57.00																																																																									
-3 .....	469.00	-17 .....	314.00	-Z .....	0.00																																																																									
	<p><b>STACK FLASHING FITTING</b></p> <table border="1"> <thead> <tr> <th colspan="4">LIST PRICE</th> </tr> <tr> <th>PIPE SIZE</th> <th>1 1/2"</th> <th>2"</th> <th>3"</th> </tr> </thead> <tbody> <tr> <td></td> <td>\$87.00</td> <td>\$87.00</td> <td>\$100.00</td> </tr> <tr> <th>PIPE SIZE</th> <th>4"</th> <th>5"</th> <th>6"</th> </tr> <tr> <td></td> <td>\$129.00</td> <td>\$187.00</td> <td>\$187.00</td> </tr> <tr> <td colspan="4"><b>ADD FOR OPTIONS:</b></td> </tr> <tr> <td>-20 .....</td> <td colspan="3">\$85.00</td> </tr> </tbody> </table>	LIST PRICE				PIPE SIZE	1 1/2"	2"	3"		\$87.00	\$87.00	\$100.00	PIPE SIZE	4"	5"	6"		\$129.00	\$187.00	\$187.00	<b>ADD FOR OPTIONS:</b>				-20 .....	\$85.00			<p><b>Roof Drain OPTION DESCRIPTIONS</b></p> <ul style="list-style-type: none"> <li>-AE LEVELEZE® Adjustable Extension</li> <li>-CR Clamping Drain Receiver</li> <li>-VP Vandal-Proof Dome</li> <li>-1 Deck Clamp Assembly</li> <li>-1C Drain Receiver Clips</li> <li>-2 Drain Receiver</li> <li>-3 Deck Clamp Assembly and Drain Receiver</li> <li>-3C Drain Receiver and Drain Receiver Clips</li> <li>-4 Secondary Flashing Clamp (use with -AE Only)</li> <li>-10 Fixed Extension Collar, Cast Iron</li> <li>-10-20 Fixed Extension Collar, Galvanized</li> <li>-17 2" High Solid Clamping Collar</li> <li>-20 Galvanized Cast Iron Parts</li> <li>-23 Rough Bronze Dome</li> <li>-63 All Rough Bronze</li> <li>-65 All Rough Nikaloy</li> </ul> <p><b>Outlets</b></p> <ul style="list-style-type: none"> <li>-66 No-Hub Side Outlet, 2" - 6"</li> <li>-T Threaded Outlet</li> <li>-TSO Threaded Side Outlet</li> <li>-X Inside Caulk Outlet</li> <li>-Y Hub Outlet with Gasket, 2" - 4"</li> <li>-Z No-Hub Spigot Outlet</li> </ul>																																																
LIST PRICE																																																																														
PIPE SIZE	1 1/2"	2"	3"																																																																											
	\$87.00	\$87.00	\$100.00																																																																											
PIPE SIZE	4"	5"	6"																																																																											
	\$129.00	\$187.00	\$187.00																																																																											
<b>ADD FOR OPTIONS:</b>																																																																														
-20 .....	\$85.00																																																																													
	<p><b>VENT STACK FLASHING SLEEVE</b></p> <table border="1"> <thead> <tr> <th colspan="4">LIST PRICE</th> </tr> <tr> <th>PIPE SIZE</th> <th>1 1/2"</th> <th>2"</th> <th>3"</th> </tr> </thead> <tbody> <tr> <td></td> <td>\$28.00</td> <td>\$28.00</td> <td>\$50.00</td> </tr> <tr> <th>PIPE SIZE</th> <th>4"</th> <th>5"</th> <th>6"</th> </tr> <tr> <td></td> <td>\$57.00</td> <td>\$74.00</td> <td>\$144.00</td> </tr> <tr> <td colspan="4"><b>ADD FOR OPTIONS:</b></td> </tr> <tr> <td>-20 .....</td> <td colspan="3">\$37.00</td> </tr> </tbody> </table>	LIST PRICE				PIPE SIZE	1 1/2"	2"	3"		\$28.00	\$28.00	\$50.00	PIPE SIZE	4"	5"	6"		\$57.00	\$74.00	\$144.00	<b>ADD FOR OPTIONS:</b>				-20 .....	\$37.00																																																			
LIST PRICE																																																																														
PIPE SIZE	1 1/2"	2"	3"																																																																											
	\$28.00	\$28.00	\$50.00																																																																											
PIPE SIZE	4"	5"	6"																																																																											
	\$57.00	\$74.00	\$144.00																																																																											
<b>ADD FOR OPTIONS:</b>																																																																														
-20 .....	\$37.00																																																																													
	<p><b>VANDAL-PROOF VENT CAP</b></p> <table border="1"> <thead> <tr> <th colspan="5">LIST PRICE</th> </tr> <tr> <th>PIPE SIZE</th> <th>1 1/2"</th> <th>2"</th> <th>2 1/2"</th> <th>3"</th> </tr> </thead> <tbody> <tr> <td></td> <td>\$192.00</td> <td>\$192.00</td> <td>\$216.00</td> <td>\$216.00</td> </tr> <tr> <th>PIPE SIZE</th> <th>4"</th> <th>5"</th> <th>6"</th> <td></td> </tr> <tr> <td></td> <td>\$242.00</td> <td>\$283.00</td> <td>\$309.00</td> <td></td> </tr> <tr> <td colspan="5"><b>ADD FOR OPTIONS:</b></td> </tr> <tr> <td>-20 .....</td> <td>\$80.00</td> <td>-63 .....</td> <td>\$192.00</td> <td>-65 .....</td> <td>\$209.00</td> </tr> </tbody> </table>	LIST PRICE					PIPE SIZE	1 1/2"	2"	2 1/2"	3"		\$192.00	\$192.00	\$216.00	\$216.00	PIPE SIZE	4"	5"	6"			\$242.00	\$283.00	\$309.00		<b>ADD FOR OPTIONS:</b>					-20 .....	\$80.00	-63 .....	\$192.00	-65 .....	\$209.00																																									
LIST PRICE																																																																														
PIPE SIZE	1 1/2"	2"	2 1/2"	3"																																																																										
	\$192.00	\$192.00	\$216.00	\$216.00																																																																										
PIPE SIZE	4"	5"	6"																																																																											
	\$242.00	\$283.00	\$309.00																																																																											
<b>ADD FOR OPTIONS:</b>																																																																														
-20 .....	\$80.00	-63 .....	\$192.00	-65 .....	\$209.00																																																																									

	<b>ROUND NIKALOY SUPER-FLO® STRAINER</b>						<b>ROUND NIKALOY TRACTOR STRAINER</b>				
	<b>LIST PRICE</b>						<b>LIST PRICE</b>				
	Strainer	Strainer Only	With 30000	With 30304	With 30002-ST		Strainer	Strainer Only	With 30000	With 30304	With 30002-ST
	5A	\$133.00	\$220.00	\$173.00	\$427.00		6E	\$338.00	\$425.00	\$378.00	\$632.00
	6A	183.00	270.00	223.00	477.00		7E	426.00	513.00	466.00	720.00
	7A	225.00	312.00	265.00	519.00		9E	624.00	711.00	664.00	918.00
	8A	305.00	392.00	345.00	599.00		<b>ADD FOR OPTIONS:</b>				
	9A*	448.00	535.00	488.00	742.00		-2 (6E) .....	Deduct \$27.00	-93 .....	Deduct \$263.00	
	10A*	448.00	535.00	488.00	742.00		-2 (7E) .....	Deduct 43.00	-J .....	.....\$174.00	
	<b>ADD FOR OPTIONS:</b>						-2 (9E) .....	Deduct 50.00	-VP .....	.....\$25.00	
	-SS (5A - 8A) .....	\$0.00	-80 .....	.....\$50.00		-80 .....	.....50.00				
	-2 (5A) .....	Deduct 11.00	-5A-CP .....	.....20.00							
	-2 (6A) .....	Deduct 27.00	-6A-CP .....	.....22.00							
	-2 (7A) .....	Deduct 16.00	-J .....	.....\$174.00							
	-2 (8A) .....	Deduct 21.00	-VP .....	.....\$25.00							
	-2 (9A, 10A)* ..	Deduct 28.00									
	* Not SUPER-FLO® Design										
	<b>ROUND NIKALOY STRAINER w/CLAMP DEVICE</b>						<b>ROUND NIKALOY STRAINER w/EXTENDED RIM</b>				
	<b>LIST PRICE</b>						<b>LIST PRICE</b>				
	Strainer	Strainer Only	With 30000	With 30304	With 30002-ST		Strainer	Strainer Only	With 30000	With 30304	With 30002-ST
	6AD	\$641.00	\$728.00	\$681.00	\$935.00		6E1	\$360.00	\$447.00	\$400.00	\$654.00
	<b>ADD FOR OPTIONS:</b>						7E1	426.00	513.00	466.00	720.00
	-2 .....	Deduct \$73.00	-J .....	.....\$174.00		9E1	631.00	718.00	671.00	925.00	
	-80 .....	.....50.00	-VP .....	.....\$25.00		<b>ADD FOR OPTIONS:</b>					
						-2 (6E1) .....	Deduct \$49.00	-80 .....	.....\$50.00		
						-2 (7E1) .....	Deduct 44.00	-J .....	.....\$174.00		
						-2 (9E1) .....	Deduct 59.00	-VP .....	.....\$25.00		
	<b>ROUND NIKALOY STRAINER WITH TILE FLANGE</b>						<b>ROUND NIKALOY STRAINER w/ROUND FUNNEL</b>				
	<b>LIST PRICE</b>						<b>LIST PRICE</b>				
	Strainer	Strainer Only	With 30000	With 30304	With 30002-ST		Strainer	Strainer Only	With 30000	With 30304	With 30002-ST
	6AF	\$426.00	\$513.00	\$466.00	\$720.00		7E2	\$421.00	\$508.00	\$461.00	\$715.00
	<b>ADD FOR OPTIONS:</b>						<b>ADD FOR OPTIONS:</b>				
	-2 .....	Deduct \$43.00	-J .....	.....\$174.00		-2 .....	Deduct \$44.00	-J .....	.....\$174.00		
	-80 .....	.....50.00	-VP .....	.....\$25.00		-80 .....	.....50.00	-VP .....	.....\$25.00		
	<b>ROUND NIKALOY NON-CLOG STRAINER WITH INTEGRAL BUCKET</b>						<b>ROUND NIKALOY STRAINER w/OVAL FUNNEL</b>				
	<b>LIST PRICE</b>						<b>LIST PRICE</b>				
	Strainer	Strainer Only	With 30000	With 30304	With 30002-ST		Strainer	Strainer Only	With 30000	With 30304	With 30002-ST
	5C	\$353.00	\$440.00	\$393.00	\$647.00		7E3	\$629.00	\$716.00	\$669.00	\$923.00
	<b>ADD FOR OPTIONS:</b>						<b>ADD FOR OPTIONS:</b>				
	-2 .....	Deduct \$20.00	-VP .....	.....\$25.00		-2 .....	Deduct \$44.00	-J .....	.....\$174.00		
						-80 .....	.....50.00	-VP .....	.....\$25.00		
	<b>ROUND NIKALOY DOME STRAINER</b>					<b>Strainer OPTION DESCRIPTIONS</b>					
	<b>LIST PRICE</b>										
	Strainer	Strainer Only	With 30000	With 30304	With 30002-ST	-CP	Chrome Plated				
	5D	\$225.00	\$312.00	\$265.00	\$519.00	-J	Backwater Valve				
	6D	287.00	374.00	327.00	581.00	-SS	Stainless Steel				
	<b>ADD FOR OPTIONS:</b>					-VP	Secured Grate, Vandal-Proof Screws				
	-2 (5D) .....	Deduct \$17.00	-J .....	.....\$174.00		-2	Satin Finish Bronze				
	-2 (6D) .....	Deduct 36.00	-VP .....	.....\$25.00		-80	Perforated Stainless Steel Basket				
	-80 .....	.....50.00				-93	Cast Iron Strainer				

 <p><b>F</b></p>	<p><b>ROUND NIKALOY STRAINER WITH SOLID THREADED COVER</b></p> <p><b>LIST PRICE</b></p> <table border="1"> <thead> <tr> <th>Strainer</th> <th>Strainer Only</th> <th>With 30000</th> <th>With 30304</th> <th>With 30002-ST</th> </tr> </thead> <tbody> <tr> <td>6F</td> <td>\$432.00</td> <td>\$519.00</td> <td>\$472.00</td> <td>\$726.00</td> </tr> </tbody> </table> <p><b>ADD FOR OPTIONS:</b></p> <p>-2 .....Deduct \$34.00    -80 .....\$50.00                      -63 .....63.00    -J .....174.00</p>	Strainer	Strainer Only	With 30000	With 30304	With 30002-ST	6F	\$432.00	\$519.00	\$472.00	\$726.00	 <p><b>M</b></p>	<p><b>ROUND CHROME PLATED OVERFLOW STANDPIPE WITH DOME</b></p> <p><b>LIST PRICE</b></p> <table border="1"> <thead> <tr> <th>Strainer</th> <th>Standpipe 6" Std.</th> <th>With 30000</th> <th>With 30304</th> <th>With 30002-ST</th> </tr> </thead> <tbody> <tr> <td>2M</td> <td>\$812.00</td> <td>\$899.00</td> <td>\$852.00</td> <td>\$1,106.00</td> </tr> <tr> <td>3M</td> <td>1,037.00</td> <td>1,124.00</td> <td>1,077.00</td> <td>1,331.00</td> </tr> </tbody> </table> <p><b>ADD FOR OPTIONS:</b></p> <p>-2 (2M).....Deduct \$138.00    -24 (3M).....Deduct \$174.00                      -2 (3M).....Deduct 86.00    -PF .....159.00                      -24 (2M).....Deduct 130.00</p> <p>For Each Inch Over 6" Standard    CP    -2</p> <p>Add for 2M    \$62.00    \$45.00                      Add for 3M    88.00    78.00</p>	Strainer	Standpipe 6" Std.	With 30000	With 30304	With 30002-ST	2M	\$812.00	\$899.00	\$852.00	\$1,106.00	3M	1,037.00	1,124.00	1,077.00	1,331.00																									
Strainer	Strainer Only	With 30000	With 30304	With 30002-ST																																																	
6F	\$432.00	\$519.00	\$472.00	\$726.00																																																	
Strainer	Standpipe 6" Std.	With 30000	With 30304	With 30002-ST																																																	
2M	\$812.00	\$899.00	\$852.00	\$1,106.00																																																	
3M	1,037.00	1,124.00	1,077.00	1,331.00																																																	
 <p><b>F4, F6</b></p>	<p><b>ROUND NIKALOY FUNNEL ASSEMBLIES</b></p> <p><b>LIST PRICE</b></p> <table border="1"> <thead> <tr> <th>Funnel</th> <th></th> </tr> </thead> <tbody> <tr> <td>F4</td> <td>\$195.00</td> </tr> <tr> <td>F6</td> <td>288.00</td> </tr> </tbody> </table> <p><b>ADD FOR OPTIONS:</b></p> <p>-2 .....Deduct \$28.00    -93 (F4) .....Deduct \$114.00                      -92 (F4) .....Deduct 88.00    -93 (F6) .....Deduct 157.00                      -92 (F6) .....Deduct 132.00</p>	Funnel		F4	\$195.00	F6	288.00	 <p><b>P</b></p>	<p><b>ANGLE NIKALOY STRAINER</b></p> <p><b>LIST PRICE</b></p> <table border="1"> <thead> <tr> <th>Strainer</th> <th>Strainer Only</th> <th>With 30000</th> <th>With 30304</th> <th>With 30002-ST</th> </tr> </thead> <tbody> <tr> <td>4P</td> <td>\$812.00</td> <td>\$899.00</td> <td>\$852.00</td> <td>\$1,106.00</td> </tr> <tr> <td>6P</td> <td>1,037.00</td> <td>1,124.00</td> <td>1,077.00</td> <td>1,331.00</td> </tr> </tbody> </table> <p><b>ADD FOR OPTIONS:</b></p> <p>-2 (4P) .....Deduct \$69.00    -J .....\$174.00                      -2 (6P) .....Deduct 86.00    -VP .....25.00                      -80 .....54.00</p>	Strainer	Strainer Only	With 30000	With 30304	With 30002-ST	4P	\$812.00	\$899.00	\$852.00	\$1,106.00	6P	1,037.00	1,124.00	1,077.00	1,331.00																													
Funnel																																																					
F4	\$195.00																																																				
F6	288.00																																																				
Strainer	Strainer Only	With 30000	With 30304	With 30002-ST																																																	
4P	\$812.00	\$899.00	\$852.00	\$1,106.00																																																	
6P	1,037.00	1,124.00	1,077.00	1,331.00																																																	
 <p><b>F8, F9</b></p>	<p><b>OVAL NIKALOY FUNNEL ASSEMBLIES</b></p> <p><b>LIST PRICE</b></p> <table border="1"> <thead> <tr> <th>Funnel</th> <th></th> </tr> </thead> <tbody> <tr> <td>F8</td> <td>\$195.00</td> </tr> <tr> <td>F9</td> <td>404.00</td> </tr> </tbody> </table> <p><b>ADD FOR OPTIONS:</b></p> <p>-2 .....Deduct \$28.00    -93 (F8) .....Deduct \$114.00                      -92 (F8) .....Deduct 88.00    -93 (F9) .....Deduct 208.00                      -92 (F9) .....Deduct 181.00</p>	Funnel		F8	\$195.00	F9	404.00	 <p><b>R</b></p>	<p><b>RECTANGULAR NIKALOY STRAINER</b></p> <p><b>LIST PRICE</b></p> <table border="1"> <thead> <tr> <th>Strainer</th> <th>Strainer Only</th> <th>With 30000</th> <th>With 30304</th> <th>With 30002-ST</th> </tr> </thead> <tbody> <tr> <td>5R</td> <td>\$399.00</td> <td>\$486.00</td> <td>\$439.00</td> <td>\$693.00</td> </tr> <tr> <td>6R</td> <td>572.00</td> <td>659.00</td> <td>612.00</td> <td>866.00</td> </tr> <tr> <td>7R</td> <td>613.00</td> <td>700.00</td> <td>653.00</td> <td>907.00</td> </tr> <tr> <td>8R</td> <td>925.00</td> <td>1,012.00</td> <td>965.00</td> <td>1,219.00</td> </tr> </tbody> </table> <p><b>ADD FOR OPTIONS:</b></p> <p>-2 (5R) .....Deduct \$36.00    -80 .....\$50.00                      -2 (6R, 7R) .....Deduct 62.00    -J .....174.00                      -2 (8R) .....Deduct 120.00    -VP .....25.00</p>	Strainer	Strainer Only	With 30000	With 30304	With 30002-ST	5R	\$399.00	\$486.00	\$439.00	\$693.00	6R	572.00	659.00	612.00	866.00	7R	613.00	700.00	653.00	907.00	8R	925.00	1,012.00	965.00	1,219.00																			
Funnel																																																					
F8	\$195.00																																																				
F9	404.00																																																				
Strainer	Strainer Only	With 30000	With 30304	With 30002-ST																																																	
5R	\$399.00	\$486.00	\$439.00	\$693.00																																																	
6R	572.00	659.00	612.00	866.00																																																	
7R	613.00	700.00	653.00	907.00																																																	
8R	925.00	1,012.00	965.00	1,219.00																																																	
 <p><b>G</b></p>	<p><b>ROUND NIKALOY STRAINER WITH SOLID HINGED COVER</b></p> <p><b>LIST PRICE</b></p> <table border="1"> <thead> <tr> <th>Strainer</th> <th>Strainer Only</th> <th>With 30000</th> <th>With 30304</th> <th>With 30002-ST</th> </tr> </thead> <tbody> <tr> <td>5G</td> <td>\$311.00</td> <td>\$398.00</td> <td>\$351.00</td> <td>\$605.00</td> </tr> <tr> <td>6G</td> <td>354.00</td> <td>441.00</td> <td>394.00</td> <td>648.00</td> </tr> <tr> <td>7G</td> <td>552.00</td> <td>639.00</td> <td>592.00</td> <td>846.00</td> </tr> <tr> <td>8G</td> <td>561.00</td> <td>648.00</td> <td>601.00</td> <td>855.00</td> </tr> </tbody> </table> <p><b>ADD FOR OPTIONS:</b></p> <p>-2 (5G) .....Deduct \$25.00    -2 (8G) .....Deduct \$50.00                      -2 (6G) .....Deduct 49.00    -J .....174.00                      -2 (7G) .....Deduct 67.00    -VP .....25.00</p>	Strainer	Strainer Only	With 30000	With 30304	With 30002-ST	5G	\$311.00	\$398.00	\$351.00	\$605.00	6G	354.00	441.00	394.00	648.00	7G	552.00	639.00	592.00	846.00	8G	561.00	648.00	601.00	855.00	 <p><b>S</b></p>	<p><b>SQUARE NIKALOY SUPER-FLO® STRAINER</b></p> <p><b>LIST PRICE</b></p> <table border="1"> <thead> <tr> <th>Strainer</th> <th>Strainer Only</th> <th>With 30000</th> <th>With 30304</th> <th>With 30002-ST</th> </tr> </thead> <tbody> <tr> <td>5S</td> <td>\$208.00</td> <td>\$295.00</td> <td>\$248.00</td> <td>\$502.00</td> </tr> <tr> <td>6S</td> <td>242.00</td> <td>329.00</td> <td>282.00</td> <td>536.00</td> </tr> <tr> <td>8S</td> <td>390.00</td> <td>477.00</td> <td>430.00</td> <td>684.00</td> </tr> <tr> <td>9S*</td> <td>519.00</td> <td>606.00</td> <td>559.00</td> <td>813.00</td> </tr> </tbody> </table> <p><b>ADD FOR OPTIONS:</b></p> <p>-SS (5S - 8S) .....\$0.00    -80 .....\$50.00                      -2 (5S) .....Deduct 25.00    -CP (5S) .....25.00                      -2 (6S) .....Deduct 16.00    -CP (6S) .....30.00                      -2 (8S) .....Deduct 44.00    -J .....174.00                      -2 (9S) * .....Deduct 50.00    -VP .....25.00</p> <p>* Not SUPER-FLO® design</p>	Strainer	Strainer Only	With 30000	With 30304	With 30002-ST	5S	\$208.00	\$295.00	\$248.00	\$502.00	6S	242.00	329.00	282.00	536.00	8S	390.00	477.00	430.00	684.00	9S*	519.00	606.00	559.00	813.00
Strainer	Strainer Only	With 30000	With 30304	With 30002-ST																																																	
5G	\$311.00	\$398.00	\$351.00	\$605.00																																																	
6G	354.00	441.00	394.00	648.00																																																	
7G	552.00	639.00	592.00	846.00																																																	
8G	561.00	648.00	601.00	855.00																																																	
Strainer	Strainer Only	With 30000	With 30304	With 30002-ST																																																	
5S	\$208.00	\$295.00	\$248.00	\$502.00																																																	
6S	242.00	329.00	282.00	536.00																																																	
8S	390.00	477.00	430.00	684.00																																																	
9S*	519.00	606.00	559.00	813.00																																																	
 <p><b>H</b></p>	<p><b>ROUND NIKALOY STRAINER WITH HINGED GRATE</b></p> <p><b>LIST PRICE</b></p> <table border="1"> <thead> <tr> <th>Strainer</th> <th>Strainer Only</th> <th>With 30000</th> <th>With 30304</th> <th>With 30002-ST</th> </tr> </thead> <tbody> <tr> <td>5H</td> <td>\$260.00</td> <td>\$347.00</td> <td>\$300.00</td> <td>\$554.00</td> </tr> <tr> <td>6H</td> <td>287.00</td> <td>374.00</td> <td>327.00</td> <td>581.00</td> </tr> <tr> <td>7H</td> <td>354.00</td> <td>441.00</td> <td>394.00</td> <td>648.00</td> </tr> <tr> <td>8H</td> <td>399.00</td> <td>486.00</td> <td>439.00</td> <td>693.00</td> </tr> </tbody> </table> <p><b>ADD FOR OPTIONS:</b></p> <p>-2 (5H) .....Deduct \$18.00    -80 (6H - 8H) .....\$50.00                      -2 (6H) .....Deduct 27.00    -J .....174.00                      -2 (7H) .....Deduct 16.00    -VP .....25.00                      -2 (8H) .....Deduct 36.00</p>	Strainer	Strainer Only	With 30000	With 30304	With 30002-ST	5H	\$260.00	\$347.00	\$300.00	\$554.00	6H	287.00	374.00	327.00	581.00	7H	354.00	441.00	394.00	648.00	8H	399.00	486.00	439.00	693.00	 <p><b>T</b></p>	<p><b>SQUARE NIKALOY STRAINER w/HINGED GRATE</b></p> <p><b>LIST PRICE</b></p> <table border="1"> <thead> <tr> <th>Strainer</th> <th>Strainer Only</th> <th>With 30000</th> <th>With 30304</th> <th>With 30002-ST</th> </tr> </thead> <tbody> <tr> <td>5T</td> <td>\$305.00</td> <td>\$392.00</td> <td>\$345.00</td> <td>\$599.00</td> </tr> <tr> <td>6T</td> <td>367.00</td> <td>454.00</td> <td>407.00</td> <td>661.00</td> </tr> <tr> <td>9T</td> <td>668.00</td> <td>755.00</td> <td>708.00</td> <td>962.00</td> </tr> </tbody> </table> <p><b>ADD FOR OPTIONS:</b></p> <p>-2 (5T) .....Deduct \$25.00    -J .....\$174.00                      -2 (6T) .....Deduct 18.00    -SC (6T) .....115.00                      -2 (9T) .....Deduct 50.00    -VP .....25.00                      -80 (6T, 9T).....50.00</p>	Strainer	Strainer Only	With 30000	With 30304	With 30002-ST	5T	\$305.00	\$392.00	\$345.00	\$599.00	6T	367.00	454.00	407.00	661.00	9T	668.00	755.00	708.00	962.00					
Strainer	Strainer Only	With 30000	With 30304	With 30002-ST																																																	
5H	\$260.00	\$347.00	\$300.00	\$554.00																																																	
6H	287.00	374.00	327.00	581.00																																																	
7H	354.00	441.00	394.00	648.00																																																	
8H	399.00	486.00	439.00	693.00																																																	
Strainer	Strainer Only	With 30000	With 30304	With 30002-ST																																																	
5T	\$305.00	\$392.00	\$345.00	\$599.00																																																	
6T	367.00	454.00	407.00	661.00																																																	
9T	668.00	755.00	708.00	962.00																																																	

	<b>CAST IRON STRAINER EXTENSION</b>						<b>BODY ASSEMBLY WITH SHALLOW TRAP</b>		
	<b>LIST PRICE</b>						<b>LIST PRICE</b>		
	Ext.	Ext. Only	With 30000	With 30304	With 30002-ST	PIPE SIZE	30002-ST		
	2W	\$63.00	\$150.00	\$103.00	\$357.00	2"	\$294.00		
Can be used with all Floor Drain Bodies on this Page.									
<b>WF6A</b> <b>WF6S</b>  	<b>NIKALOY STRAINERS FOR COMPOSITION DECKS</b>						<b>NO-HUB CAST IRON BODY</b>		
	<b>LIST PRICE</b>						<b>LIST PRICE</b>		
	Strainer	Strainer Only	With 30000	With 30304	With 30002-ST		PIPE SIZE	30304	
	WF6A	\$494.00	\$581.00	\$534.00	\$788.00		4"	\$40.00	
<b>ADD FOR OPTIONS:</b>									
-2 (6A) .....Deduct \$27.00    -J .....\$174.00 -2 (6S) .....Deduct 16.00    -VP .....\$25.00 -80 .....50.00									
Can be used with all Floor Drain Bodies on this Page.									
<b>BODIES ONLY</b>									
	<b>30000 BODY ASSEMBLY</b>						<b>BODY ASSEMBLY WITH TRAP &amp; FLUSH WITH FLOOR CLEANOUT</b>		
	<b>LIST PRICE</b>						<b>LIST PRICE</b>		
	PIPE SIZE	30000	30000-TSO	30002-ST	30000-PD		PIPE SIZE	30500	
	2" - 4"	\$87.00	\$187.00	\$294.00	\$326.00		2" - 4"	\$519.00	
<b>ADD FOR OPTIONS:</b>									
-TSO .....\$100.00    -91 .....\$555.00 -ST .....171.00    -92 .....90.00 -PD .....239.00    -T .....36.00 -MD .....50.00    -X .....0.00 -ARE .....80.00    -Y .....0.00 -49 .....0.00    -Z .....0.00 -50 .....STD									
	<b>30000-PD SECURITY BODY ASSEMBLY FOR PRISONS</b>					<b>OPTION DESCRIPTIONS</b>  <b>Strainers</b> -CP Chrome Plated -J Backwater Valve -PF Perforated Standpipe -SC Solid Cover -SS Stainless Steel -VP Secured Grate, Vandal-Proof Screws -2 Satin Finish Bronze -24 Less Dome -63 Spanner Wrench -80 Perforated Stainless Steel Basket -92 Galvanized Cast Iron -93 Cast Iron  <b>Bodies Only</b> -ARE Acid-Resisting Epoxy -C Bolted Flashing Clamp Device -MD PVC Clamp Collar with 3" Socket Connection -PD Prison Drain -ST Shallow Trap -49 3/4" Primer Tap -50 1/2" Primer Tap -51 1-1/2" Threaded Auxiliary Inlet -52 2" Threaded Auxiliary Inlet -91 Rough Bronze Body -92 Galvanized Cast Iron Parts  <b>Outlets</b> -T Threaded Outlet -TSO Threaded Side Outlet -X Inside Caulk Outlet -Y Hub Outlet with Gasket -Z No-Hub Outlet			
	<b>LIST PRICE</b>								
	PIPE SIZE	30000-PD							
2", 3"	\$326.00								
<b>ADD FOR OPTIONS:</b>									
-50 .....\$0.00    -C .....\$0.00 -92 .....90.00    -T .....0.00									
	<b>30000-TSO BODY ASSEMBLY WITH THREADED SIDE OUTLET</b>								
	<b>LIST PRICE</b>								
	PIPE SIZE	30000-TSO							
	2" - 4"	\$187.00							
<b>ADD FOR OPTIONS:</b>									
-ARE .....\$80.00    -92 .....\$90.00 -49 .....0.00    -TSO .....0.00 -50 .....0.00									

# FLOOR DRAINS



## ADJUSTABLE FLOOR DRAIN ASSEMBLIES



  <b>NEW</b> TRAP NOT SHOWN	<b>30802-4CP</b>		BODY WITH 2" SHALLOW TRAP & ROUND CHROME PLATED STRAINER	
	<b>LIST PRICE</b>			
	PIPE SIZE	30802-4CP		
	2"	\$250.00		
ADD FOR OPTIONS:				
-SQ	\$30.00	-T	\$0.00	
-LT	Deduct 100.00		-Z	0.00

	<b>30900-9AD</b>		BODY WITH 9" ROUND NIKALOY STRAINER	
	<b>LIST PRICE</b>			
	PIPE SIZE	30900-9AD		
	2" - 4"	\$931.00		
ADD FOR OPTIONS:				
-2	Deduct \$95.00		-T	\$36.00
-66 (2", 3")	100.00		-X	0.00
-66 (4")	143.00		-Y	0.00
-92	90.00		-Z	0.00
-VP	25.00			

  <b>NEW</b>	<b>31000</b>		BODY WITH 5" ROUND NIKALOY TOP	
	<b>LIST PRICE</b>			
	PIPE SIZE	31000		
	2" - 4"	\$175.00		
ADD FOR OPTIONS:				
-SQ	\$75.00	-Y (2", 3")	\$0.00	
-C	15.00	-Z (3", 4")	0.00	

## FLOOR DRAINS

	<b>32100</b>		SUPER-FLO® 9" TOP		
	<b>LIST PRICE</b>				
	PIPE SIZE	32100			
	2" - 4"	\$232.00			
ADD FOR OPTIONS:					
-AE	\$93.00	-13-2	\$320.00	-81	\$43.00
-TG	56.00	-15	112.00	-84	133.00
-LC1	606.00	-39	223.00	-88	19.00
-LC2	555.00	-VP	68.00	-92	196.00
-1	231.00	-ARE	237.00	-T	36.00
-2	197.00	-44*	129.00	-X	0.00
-7	108.00	-44 -92*	263.00	-Y	0.00
-11	29.00	-49	75.00	-Z	0.00
-13	38.00	-50	75.00		
-13-1	400.00	-66	198.00		
* Specify Height, Each 3" or Fraction					





 	<b>32150</b>		SUPER-FLO® 9" BLOOD DRAIN	
	<b>LIST PRICE</b>			
	PIPE SIZE	32150		
	2" - 4"	\$694.00		
ADD FOR OPTIONS:				
-1	\$1,273.00	-ARE	\$475.00	
-2	1,029.00	-T	36.00	
-7	250.00	-X	0.00	
-44*	169.00	-Y	0.00	
-44 -92*	385.00	-Z	0.00	
-92	389.00			
* Specify Height, Each 3" or Fraction				

	<b>32160</b>		DEEP BODY, 9" TRACTOR TOP		
	<b>LIST PRICE</b>				
	PIPE SIZE	32160			
	3", 4"	\$628.00			
ADD FOR OPTIONS:					
-7	\$87.00	-51	159.00	-62 (4")▲	302.00
-12	148.00	-52	159.00	-66	170.00
-15	112.00	-53	213.00	-71▲	\$87.00
-19	231.00	-54	213.00	-81▲	87.00
-20	192.00	-53 -92	243.00	-88▲	25.00
-44*	129.00	-54 -92	243.00	-92	258.00
-49	69.00	-60	282.00	-ARE	428.00
-50	69.00	-62 (3")▲	179.00	-VP	87.00
				-X	0.00
* Specify Height, Each 3" or Fraction ▲ Cannot be installed when BWV is ordered.					

	<b>32200</b>		SHALLOW SUMP, SUPER-FLO® 12" TOP		
	<b>LIST PRICE</b>				
	PIPE SIZE	32200			
	2" - 6" 8"	\$483.00 612.00			
ADD FOR OPTIONS:					
-AE	\$195.00	-13 -1	\$571.00	-50	\$69.00
-81	211.00	-13 -2	489.00	-66	170.00
-SD	43.00	-15	109.00	-84	192.00
-1	345.00	-ARE	386.00	-88	29.00
-2	299.00	-VP	68.00	-92	296.00
-4*	86.00	-44**	114.00	-T	36.00
-7	119.00	-44 -92**	230.00	-X	0.00
-13	63.00	-49	69.00	-Y	0.00
				-Z	0.00
* Available on -AE Only ** Specify Height, Each 3" or Fraction					

	<b>32300</b>		MEDIUM SUMP, SUPER-FLO® 12" TOP		
	<b>LIST PRICE</b>				
	PIPE SIZE	32300			
	2" - 8"	\$585.00			
ADD FOR OPTIONS:					
-81	\$115.00	-13 -2	\$489.00	-50	\$69.00
-SD	71.00	-15	109.00	-66	170.00
-1	345.00	-ARE	441.00	-84	192.00
-2	299.00	-VP	68.00	-88	29.00
-7	119.00	-44*	114.00	-92	296.00
-13	63.00	-44 -92*	230.00	-X	0.00
-13 -1	571.00	-49	69.00	-Z	0.00
* Specify Height, Each 2" or Fraction					

	<b>32330</b>		DEEP SUMP, SUPER-FLO® 12" TOP w/BUCKET	
	<b>LIST PRICE</b>			
	PIPE SIZE	32330		
	2" - 6" 8"	\$819.00 959.00		
ADD FOR OPTIONS:				
-SD	\$0.00	-50	\$75.00	
-15	109.00	-66	170.00	
-VP	68.00	-70	Deduct 139.00	
-19	332.00	-84	187.00	
-20	287.00	-88	43.00	
-44*	103.00	-92	553.00	
-44 -92*	209.00	-X	0.00	
-49	75.00	-Z	0.00	
* On -SD Only, Specify Height, Per Inch				

	<b>15" EXTRA HEAVY-DUTY TOP</b>	
	<b>LIST PRICE</b>	
	<b>PIPE SIZE</b>	<b>34710</b>
	4"	\$719.00
	5", 6"	851.00
	8"	1,016.00
<b>ADD FOR OPTIONS:</b>		
-AE .....	\$326.00	-20 .....\$737.00
-7 .....	282.00	-49 .....69.00
-15 .....	109.00	-50 .....69.00
-VP .....	66.00	-88 .....43.00
-19 .....	843.00	-92 .....409.00
		-T .....36.00
		-X .....0.00
		-Y .....0.00
		-Z .....0.00
	<b>15" EXTRA HEAVY-DUTY TOP WITH BUCKET</b>	
	<b>LIST PRICE</b>	
	<b>PIPE SIZE</b>	<b>34720</b>
	3" - 6"	\$1,348.00
<b>ADD FOR OPTIONS:</b>		
-7 .....	\$302.00	-49 .....\$69.00
-15 .....	109.00	-50 .....69.00
-VP .....	95.00	-66 .....170.00
-19 .....	843.00	-84 .....192.00
-20 .....	737.00	-88 .....43.00
		-92 .....\$905.00
		-X .....0.00
		-Z .....0.00
	<b>NON-CLOG 21" ROUND TOP WITH BUCKET</b>	
	<b>LIST PRICE</b>	
	<b>PIPE SIZE</b>	<b>34920</b>
	3" - 8"	\$7,022.00
<b>ADD FOR OPTIONS:</b>		
-12 .....	*P.O.A.	-19 .....903.00
-12 -1 .....	*P.O.A.	-20 .....\$753.00
-12 -2 .....	*P.O.A.	-C .....0.00
-15 .....	\$109.00	-49 .....69.00
-VP .....	95.00	-50 .....69.00
		-66 .....170.00
		-80 .....1,288.00
		-84 .....\$258.00
		-92 .....1,351.00
		-T .....36.00
		-X .....0.00
* PRICE ON APPLICATION		
	<b>8" SQUARE TOP</b>	
	<b>LIST PRICE</b>	
	<b>PIPE SIZE</b>	<b>35100</b>
	2" - 4"	\$379.00
<b>ADD FOR OPTIONS:</b>		
-TSO .....	\$100.00	-49 .....\$75.00
-1 .....	282.00	-50 .....STD
-2 .....	209.00	-92 .....193.00
-7 .....	96.00	-ARE .....231.00
-15 .....	109.00	-T .....36.00
		-X .....0.00
		-Y .....0.00
		-Z .....0.00
	<b>9" TOP WITH BUCKET</b>	
	<b>LIST PRICE</b>	
	<b>PIPE SIZE</b>	<b>35130</b>
	2" - 4"	\$442.00
<b>ADD FOR OPTIONS:</b>		
-1 .....	\$287.00	-VP .....\$69.00
-2 .....	209.00	-49 .....69.00
-14 -1 .....	757.00	-50 .....69.00
-14 -2 .....	716.00	-66 .....71.00
-15 .....	112.00	-70 ..Deduct 36.00
		-84 .....\$95.00
		-92 .....195.00
		-ARE .....338.00
		-X .....0.00
		-Z .....0.00

## OPTION DESCRIPTIONS

- AE LEVELEZE® Adjustable Extension
- ARE Acid Resisting Epoxy
- C Bolted Flashing Clamp Device
- LC1 Locking Cover, Satin Finish Nikaloy
- LC2 Locking Cover, Satin Finish Bronze
- LT Less Shallow Trap
- SD Special Duty Grate
- SQ Square Top
- TG Tractor Grate
- VP Secured Grate, Vandal-Proof Screws
- 1 Satin Finish Nikaloy Top
- 2 Satin Finish Bronze Top
- 4 Secondary Flashing Clamp (use with -AE only)
- 7 Ductile Iron Grate
- 11 Extra-Heavy Grate, Cast Iron
- 12 Square Top, Cast Iron
- 12-1 Square Top, Nikaloy
- 12-2 Square Top, Bronze
- 13 Dome Grate, Cast Iron
- 13-1 Dome Grate, Nikaloy
- 13-2 Dome Grate, Bronze
- 14-1 Hinged Top, Satin Finish Nikaloy
- 14-2 Hinged Top, Satin Finish Bronze
- 15 Chained Grate
- 19 C.I. Undergrate with Satin Finish Nikaloy Top
- 20 C.I. Undergrate with Satin Finish Bronze Top
- 39 Solid Cast Iron Cover
- 44 Fixed Extension Collar, Cast Iron, Specify Height
- 44-92 Fixed Extension Collar, Galvanized, Specify Height
- 49 3/4" Primer Tap
- 50 1/2" Primer Tap
- 51 1-1/2" Auxiliary Threaded Inlet
- 52 2" Auxiliary Threaded Inlet
- 53 2" Auxiliary Hub Inlet
- 54 2" Auxiliary Spigot Inlet
- 53-92 2" Auxiliary Hub Inlet, Galvanized
- 54-92 2" Auxiliary Spigot Inlet, Galvanized
- 60 Backwater Valve
- 62 "T" Handle Bronze Closure Plug
- 70 Less Bucket
- 71 Solid Cast Iron Bucket
- 81 Slotted Cast Iron Bucket
- 84 Stainless Steel Mesh Bucket Liner
- 88 Supplementary Strainer
- 92 Galvanized Cast Iron Parts











## Outlets







- 66 No-Hub Side Outlet
- T Threaded Outlet
- TSO Threaded Side Outlet
- X Inside Caulk Outlet
- Y Hub Outlet with Gasket, 2" - 4"
- Z No-Hub Outlet











# FLOOR DRAINS



 <p><b>35170</b></p>	<p><b>10" TRACTOR TOP WITH BUCKET</b></p> <p><b>LIST PRICE</b></p> <table border="1"> <tr> <td>PIPE SIZE</td> <td><b>35170</b></td> </tr> <tr> <td>3", 4"</td> <td>\$532.00</td> </tr> </table> <p><b>ADD FOR OPTIONS:</b></p> <table border="1"> <tr> <td>-1 .....</td><td>\$442.00</td> <td>-49 .....</td><td>\$75.00</td> <td>-88 .....</td><td>\$25.00</td> </tr> <tr> <td>-2 .....</td><td>373.00</td> <td>-50 .....</td><td>75.00</td> <td>-92 .....</td><td>158.00</td> </tr> <tr> <td>-15 .....</td><td>109.00</td> <td>-70 ..Deduct</td><td>44.00</td> <td>-X .....</td><td>0.00</td> </tr> <tr> <td>-VP .....</td><td>69.00</td> <td>-84 .....</td><td>125.00</td> <td>-Z .....</td><td>0.00</td> </tr> </table>	PIPE SIZE	<b>35170</b>	3", 4"	\$532.00	-1 .....	\$442.00	-49 .....	\$75.00	-88 .....	\$25.00	-2 .....	373.00	-50 .....	75.00	-92 .....	158.00	-15 .....	109.00	-70 ..Deduct	44.00	-X .....	0.00	-VP .....	69.00	-84 .....	125.00	-Z .....	0.00	 <p><b>37840</b></p>	<p><b>12" TOP WITH BUCKET</b></p> <p><b>LIST PRICE</b></p> <table border="1"> <tr> <td>PIPE SIZE</td> <td><b>37840</b></td> </tr> <tr> <td>2" - 8"</td> <td>\$1,360.00</td> </tr> </table> <p><b>ADD FOR OPTIONS:</b></p> <table border="1"> <tr> <td>-7 .....</td><td>\$277.00</td> <td>-49 .....</td><td>\$69.00</td> <td>-88 .....</td><td>\$43.00</td> </tr> <tr> <td>-14 .....</td><td>109.00</td> <td>-50 .....</td><td>69.00</td> <td>-92 .....</td><td>409.00</td> </tr> <tr> <td>-VP .....</td><td>66.00</td> <td>-66 .....</td><td>170.00</td> <td>-X .....</td><td>0.00</td> </tr> <tr> <td>-19 .....</td><td>505.00</td> <td>-70 ..Deduct</td><td>76.00</td> <td>-Z .....</td><td>0.00</td> </tr> <tr> <td>-20 .....</td><td>418.00</td> <td>-84 .....</td><td>192.00</td> <td></td><td></td> </tr> </table>	PIPE SIZE	<b>37840</b>	2" - 8"	\$1,360.00	-7 .....	\$277.00	-49 .....	\$69.00	-88 .....	\$43.00	-14 .....	109.00	-50 .....	69.00	-92 .....	409.00	-VP .....	66.00	-66 .....	170.00	-X .....	0.00	-19 .....	505.00	-70 ..Deduct	76.00	-Z .....	0.00	-20 .....	418.00	-84 .....	192.00																																
PIPE SIZE	<b>35170</b>																																																																																														
3", 4"	\$532.00																																																																																														
-1 .....	\$442.00	-49 .....	\$75.00	-88 .....	\$25.00																																																																																										
-2 .....	373.00	-50 .....	75.00	-92 .....	158.00																																																																																										
-15 .....	109.00	-70 ..Deduct	44.00	-X .....	0.00																																																																																										
-VP .....	69.00	-84 .....	125.00	-Z .....	0.00																																																																																										
PIPE SIZE	<b>37840</b>																																																																																														
2" - 8"	\$1,360.00																																																																																														
-7 .....	\$277.00	-49 .....	\$69.00	-88 .....	\$43.00																																																																																										
-14 .....	109.00	-50 .....	69.00	-92 .....	409.00																																																																																										
-VP .....	66.00	-66 .....	170.00	-X .....	0.00																																																																																										
-19 .....	505.00	-70 ..Deduct	76.00	-Z .....	0.00																																																																																										
-20 .....	418.00	-84 .....	192.00																																																																																												
 <p><b>37800</b></p>	<p><b>SHALLOW SUMP, 12" HEAVY-DUTY TOP</b></p> <p><b>LIST PRICE</b></p> <table border="1"> <tr> <td>PIPE SIZE</td> <td><b>37800</b></td> </tr> <tr> <td>2" - 4"</td> <td>\$644.00</td> </tr> </table> <p><b>ADD FOR OPTIONS:</b></p> <table border="1"> <tr> <td>-7 .....</td><td>\$269.00</td> <td>-20 .....</td><td>\$418.00</td> <td>-T .....</td><td>\$36.00</td> </tr> <tr> <td>-14 .....</td><td>109.00</td> <td>-49 .....</td><td>75.00</td> <td>-X .....</td><td>0.00</td> </tr> <tr> <td>-VP .....</td><td>66.00</td> <td>-50 .....</td><td>STD</td> <td>-Y .....</td><td>0.00</td> </tr> <tr> <td>-18 .....</td><td>253.00</td> <td>-66 .....</td><td>99.00</td> <td>-Z .....</td><td>0.00</td> </tr> <tr> <td>-19 .....</td><td>505.00</td> <td>-92 .....</td><td>227.00</td> <td></td><td></td> </tr> </table>	PIPE SIZE	<b>37800</b>	2" - 4"	\$644.00	-7 .....	\$269.00	-20 .....	\$418.00	-T .....	\$36.00	-14 .....	109.00	-49 .....	75.00	-X .....	0.00	-VP .....	66.00	-50 .....	STD	-Y .....	0.00	-18 .....	253.00	-66 .....	99.00	-Z .....	0.00	-19 .....	505.00	-92 .....	227.00			 <p><b>37900</b></p>	<p><b>14" PACKING HOUSE DRAIN</b></p> <p><b>LIST PRICE</b></p> <table border="1"> <tr> <td>PIPE SIZE</td> <td><b>37900</b></td> </tr> <tr> <td>2" - 6"</td> <td>\$1,360.00</td> </tr> <tr> <td>8"</td> <td>1,533.00</td> </tr> </table> <p><b>ADD FOR OPTIONS:</b></p> <table border="1"> <tr> <td>-4 .....</td><td>\$86.00</td> <td>-70 Deduct</td><td>\$84.00</td> <td>-X .....</td><td>\$0.00</td> </tr> <tr> <td>-15 .....</td><td>112.00</td> <td>-84 .....</td><td>192.00</td> <td>-Y .....</td><td>0.00</td> </tr> <tr> <td>-VP .....</td><td>68.00</td> <td>-88 .....</td><td>35.00</td> <td>-Z .....</td><td>0.00</td> </tr> <tr> <td>-19 .....</td><td>618.00</td> <td>-92 .....</td><td>778.00</td> <td></td><td></td> </tr> <tr> <td>-20 .....</td><td>589.00</td> <td>-T .....</td><td>36.00</td> <td></td><td></td> </tr> </table>	PIPE SIZE	<b>37900</b>	2" - 6"	\$1,360.00	8"	1,533.00	-4 .....	\$86.00	-70 Deduct	\$84.00	-X .....	\$0.00	-15 .....	112.00	-84 .....	192.00	-Y .....	0.00	-VP .....	68.00	-88 .....	35.00	-Z .....	0.00	-19 .....	618.00	-92 .....	778.00			-20 .....	589.00	-T .....	36.00																								
PIPE SIZE	<b>37800</b>																																																																																														
2" - 4"	\$644.00																																																																																														
-7 .....	\$269.00	-20 .....	\$418.00	-T .....	\$36.00																																																																																										
-14 .....	109.00	-49 .....	75.00	-X .....	0.00																																																																																										
-VP .....	66.00	-50 .....	STD	-Y .....	0.00																																																																																										
-18 .....	253.00	-66 .....	99.00	-Z .....	0.00																																																																																										
-19 .....	505.00	-92 .....	227.00																																																																																												
PIPE SIZE	<b>37900</b>																																																																																														
2" - 6"	\$1,360.00																																																																																														
8"	1,533.00																																																																																														
-4 .....	\$86.00	-70 Deduct	\$84.00	-X .....	\$0.00																																																																																										
-15 .....	112.00	-84 .....	192.00	-Y .....	0.00																																																																																										
-VP .....	68.00	-88 .....	35.00	-Z .....	0.00																																																																																										
-19 .....	618.00	-92 .....	778.00																																																																																												
-20 .....	589.00	-T .....	36.00																																																																																												
 <p><b>37810</b></p>	<p><b>MEDIUM SUMP, 12" HEAVY-DUTY TOP</b></p> <p><b>LIST PRICE</b></p> <table border="1"> <tr> <td>PIPE SIZE</td> <td><b>37810</b></td> </tr> <tr> <td>2" - 6"</td> <td>\$685.00</td> </tr> </table> <p><b>ADD FOR OPTIONS:</b></p> <table border="1"> <tr> <td>-AE .....</td><td>\$326.00</td> <td>-19 .....</td><td>\$505.00</td> <td>-88 .....</td><td>43.00</td> </tr> <tr> <td>-4* .....</td><td>86.00</td> <td>-20 .....</td><td>418.00</td> <td>-92 .....</td><td>409.00</td> </tr> <tr> <td>-7 .....</td><td>277.00</td> <td>-49 .....</td><td>69.00</td> <td>-ARE .....</td><td>423.00</td> </tr> <tr> <td>-14 .....</td><td>109.00</td> <td>-50 .....</td><td>69.00</td> <td>-T .....</td><td>36.00</td> </tr> <tr> <td>-VP .....</td><td>66.00</td> <td>-66 .....</td><td>170.00</td> <td>-X .....</td><td>0.00</td> </tr> <tr> <td>-18 .....</td><td>253.00</td> <td>-70 ..Deduct</td><td>76.00</td> <td>-Y .....</td><td>0.00</td> </tr> <tr> <td></td><td></td> <td>-84 .....</td><td>\$192.00</td> <td>-Z .....</td><td>0.00</td> </tr> </table> <p>* Available on -AE only</p>	PIPE SIZE	<b>37810</b>	2" - 6"	\$685.00	-AE .....	\$326.00	-19 .....	\$505.00	-88 .....	43.00	-4* .....	86.00	-20 .....	418.00	-92 .....	409.00	-7 .....	277.00	-49 .....	69.00	-ARE .....	423.00	-14 .....	109.00	-50 .....	69.00	-T .....	36.00	-VP .....	66.00	-66 .....	170.00	-X .....	0.00	-18 .....	253.00	-70 ..Deduct	76.00	-Y .....	0.00			-84 .....	\$192.00	-Z .....	0.00	 <p><b>37960</b></p>	<p><b>SUPER-FLO® 16" TOP</b></p> <p><b>LIST PRICE</b></p> <table border="1"> <tr> <td>PIPE SIZE</td> <td><b>37960</b></td> </tr> <tr> <td>2" - 6"</td> <td>\$1,170.00</td> </tr> </table> <p><b>ADD FOR OPTIONS:</b></p> <table border="1"> <tr> <td>-1 .....</td><td>\$1,355.00</td> <td>-15 .....</td><td>\$112.00</td> <td>-92 .....</td><td>\$579.00</td> </tr> <tr> <td>-2 .....</td><td>1,217.00</td> <td>-LF Deduct</td><td>171.00</td> <td>-92-LF .....</td><td>487.00</td> </tr> <tr> <td>-7 .....</td><td>279.00</td> <td>-C .....</td><td>258.00</td> <td>-92-LG-LF .....</td><td>442.00</td> </tr> <tr> <td>-LG Deduct</td><td>260.00</td> <td>-49 .....</td><td>87.00</td> <td>-ARE .....</td><td>See 49000</td> </tr> <tr> <td>-LG-1 Ded.</td><td>544.00</td> <td>-50 .....</td><td>87.00</td> <td>-X .....</td><td>0.00</td> </tr> <tr> <td>-LG-2 Ded.</td><td>506.00</td> <td>-81 .....</td><td>270.00</td> <td></td><td></td> </tr> <tr> <td>-11 .....</td><td>279.00</td> <td>-84 .....</td><td>192.00</td> <td></td><td></td> </tr> </table>	PIPE SIZE	<b>37960</b>	2" - 6"	\$1,170.00	-1 .....	\$1,355.00	-15 .....	\$112.00	-92 .....	\$579.00	-2 .....	1,217.00	-LF Deduct	171.00	-92-LF .....	487.00	-7 .....	279.00	-C .....	258.00	-92-LG-LF .....	442.00	-LG Deduct	260.00	-49 .....	87.00	-ARE .....	See 49000	-LG-1 Ded.	544.00	-50 .....	87.00	-X .....	0.00	-LG-2 Ded.	506.00	-81 .....	270.00			-11 .....	279.00	-84 .....	192.00		
PIPE SIZE	<b>37810</b>																																																																																														
2" - 6"	\$685.00																																																																																														
-AE .....	\$326.00	-19 .....	\$505.00	-88 .....	43.00																																																																																										
-4* .....	86.00	-20 .....	418.00	-92 .....	409.00																																																																																										
-7 .....	277.00	-49 .....	69.00	-ARE .....	423.00																																																																																										
-14 .....	109.00	-50 .....	69.00	-T .....	36.00																																																																																										
-VP .....	66.00	-66 .....	170.00	-X .....	0.00																																																																																										
-18 .....	253.00	-70 ..Deduct	76.00	-Y .....	0.00																																																																																										
		-84 .....	\$192.00	-Z .....	0.00																																																																																										
PIPE SIZE	<b>37960</b>																																																																																														
2" - 6"	\$1,170.00																																																																																														
-1 .....	\$1,355.00	-15 .....	\$112.00	-92 .....	\$579.00																																																																																										
-2 .....	1,217.00	-LF Deduct	171.00	-92-LF .....	487.00																																																																																										
-7 .....	279.00	-C .....	258.00	-92-LG-LF .....	442.00																																																																																										
-LG Deduct	260.00	-49 .....	87.00	-ARE .....	See 49000																																																																																										
-LG-1 Ded.	544.00	-50 .....	87.00	-X .....	0.00																																																																																										
-LG-2 Ded.	506.00	-81 .....	270.00																																																																																												
-11 .....	279.00	-84 .....	192.00																																																																																												
 <p><b>37820</b></p>	<p><b>DEEP SUMP, 12" HEAVY-DUTY TOP WITH BUCKET</b></p> <p><b>LIST PRICE</b></p> <table border="1"> <tr> <td>PIPE SIZE</td> <td><b>37820</b></td> </tr> <tr> <td>2" - 8"</td> <td>\$786.00</td> </tr> </table> <p><b>ADD FOR OPTIONS:</b></p> <table border="1"> <tr> <td>-AE .....</td><td>\$326.00</td> <td>-19 .....</td><td>\$505.00</td> <td>-84 .....</td><td>\$192.00</td> </tr> <tr> <td>-4* .....</td><td>86.00</td> <td>-20 .....</td><td>418.00</td> <td>-88 .....</td><td>43.00</td> </tr> <tr> <td>-7 .....</td><td>277.00</td> <td>-49 .....</td><td>69.00</td> <td>-92 .....</td><td>409.00</td> </tr> <tr> <td>-14 .....</td><td>109.00</td> <td>-50 .....</td><td>69.00</td> <td>-ARE .....</td><td>448.00</td> </tr> <tr> <td>-VP .....</td><td>66.00</td> <td>-66 .....</td><td>170.00</td> <td>-X .....</td><td>0.00</td> </tr> <tr> <td>-18 .....</td><td>253.00</td> <td>-70 ..Deduct</td><td>76.00</td> <td>-Z .....</td><td>0.00</td> </tr> </table> <p>* Available on -AE only</p>	PIPE SIZE	<b>37820</b>	2" - 8"	\$786.00	-AE .....	\$326.00	-19 .....	\$505.00	-84 .....	\$192.00	-4* .....	86.00	-20 .....	418.00	-88 .....	43.00	-7 .....	277.00	-49 .....	69.00	-92 .....	409.00	-14 .....	109.00	-50 .....	69.00	-ARE .....	448.00	-VP .....	66.00	-66 .....	170.00	-X .....	0.00	-18 .....	253.00	-70 ..Deduct	76.00	-Z .....	0.00	 <p><b>38040</b></p>	<p><b>ROUND TOP &amp; CLEANOUT</b></p> <p><b>LIST PRICE</b></p> <table border="1"> <tr> <td>PIPE SIZE</td> <td><b>38040</b></td> </tr> <tr> <td>2"</td> <td>\$578.00</td> </tr> <tr> <td>3"</td> <td>908.00</td> </tr> <tr> <td>4"</td> <td>953.00</td> </tr> </table> <p><b>ADD FOR OPTIONS:</b></p> <table border="1"> <tr> <td>-1 .....</td><td>\$351.00</td> <td>-50 .....</td><td>\$69.00</td> <td>-81-92 .....</td><td>\$96.00</td> </tr> <tr> <td>-2 .....</td><td>321.00</td> <td>-51 .....</td><td>159.00</td> <td>-84 .....</td><td>133.00</td> </tr> <tr> <td>-7 .....</td><td>115.00</td> <td>-52 .....</td><td>159.00</td> <td>-88 .....</td><td>19.00</td> </tr> <tr> <td>-11 .....</td><td>29.00</td> <td>-60 (2") .....</td><td>276.00</td> <td>-92 .....</td><td>345.00</td> </tr> <tr> <td>-15 .....</td><td>108.00</td> <td>-60 (3") .....</td><td>305.00</td> <td>-Z .....</td><td>0.00</td> </tr> <tr> <td>-VP .....</td><td>66.00</td> <td>-60 (4") .....</td><td>332.00</td> <td></td><td></td> </tr> <tr> <td>-49 .....</td><td>69.00</td> <td>-81 .....</td><td>57.00</td> <td></td><td></td> </tr> </table>	PIPE SIZE	<b>38040</b>	2"	\$578.00	3"	908.00	4"	953.00	-1 .....	\$351.00	-50 .....	\$69.00	-81-92 .....	\$96.00	-2 .....	321.00	-51 .....	159.00	-84 .....	133.00	-7 .....	115.00	-52 .....	159.00	-88 .....	19.00	-11 .....	29.00	-60 (2") .....	276.00	-92 .....	345.00	-15 .....	108.00	-60 (3") .....	305.00	-Z .....	0.00	-VP .....	66.00	-60 (4") .....	332.00			-49 .....	69.00	-81 .....	57.00				
PIPE SIZE	<b>37820</b>																																																																																														
2" - 8"	\$786.00																																																																																														
-AE .....	\$326.00	-19 .....	\$505.00	-84 .....	\$192.00																																																																																										
-4* .....	86.00	-20 .....	418.00	-88 .....	43.00																																																																																										
-7 .....	277.00	-49 .....	69.00	-92 .....	409.00																																																																																										
-14 .....	109.00	-50 .....	69.00	-ARE .....	448.00																																																																																										
-VP .....	66.00	-66 .....	170.00	-X .....	0.00																																																																																										
-18 .....	253.00	-70 ..Deduct	76.00	-Z .....	0.00																																																																																										
PIPE SIZE	<b>38040</b>																																																																																														
2"	\$578.00																																																																																														
3"	908.00																																																																																														
4"	953.00																																																																																														
-1 .....	\$351.00	-50 .....	\$69.00	-81-92 .....	\$96.00																																																																																										
-2 .....	321.00	-51 .....	159.00	-84 .....	133.00																																																																																										
-7 .....	115.00	-52 .....	159.00	-88 .....	19.00																																																																																										
-11 .....	29.00	-60 (2") .....	276.00	-92 .....	345.00																																																																																										
-15 .....	108.00	-60 (3") .....	305.00	-Z .....	0.00																																																																																										
-VP .....	66.00	-60 (4") .....	332.00																																																																																												
-49 .....	69.00	-81 .....	57.00																																																																																												
 <p><b>37830</b></p>	<p><b>12" TOP WITH LATCHING GRATE</b></p> <p><b>LIST PRICE</b></p> <table border="1"> <tr> <td>PIPE SIZE</td> <td><b>37830</b></td> </tr> <tr> <td>2" - 6"</td> <td>\$937.00</td> </tr> </table> <p><b>ADD FOR OPTIONS:</b></p> <table border="1"> <tr> <td>-7 .....</td><td>\$277.00</td> <td>-49 .....</td><td>\$69.00</td> <td>-92 .....</td><td>\$409.00</td> </tr> <tr> <td>-19 .....</td><td>505.00</td> <td>-50 .....</td><td>69.00</td> <td>-X .....</td><td>0.00</td> </tr> <tr> <td>-20 .....</td><td>418.00</td> <td>-66 .....</td><td>170.00</td> <td>-Z .....</td><td>0.00</td> </tr> <tr> <td>-21 Deduct</td><td>216.00</td> <td>-69 .....</td><td>36.00</td> <td></td><td></td> </tr> <tr> <td>-22 Deduct</td><td>143.00</td> <td>-84 .....</td><td>192.00</td> <td></td><td></td> </tr> </table>	PIPE SIZE	<b>37830</b>	2" - 6"	\$937.00	-7 .....	\$277.00	-49 .....	\$69.00	-92 .....	\$409.00	-19 .....	505.00	-50 .....	69.00	-X .....	0.00	-20 .....	418.00	-66 .....	170.00	-Z .....	0.00	-21 Deduct	216.00	-69 .....	36.00			-22 Deduct	143.00	-84 .....	192.00			 <p><b>38250A</b></p>	<p><b>ROUND TOP WITH CLEANOUT &amp; BWV</b></p> <p><b>LIST PRICE</b></p> <table border="1"> <tr> <td>PIPE SIZE</td> <td><b>38250A</b></td> </tr> <tr> <td>2"</td> <td>\$389.00</td> </tr> <tr> <td>3"</td> <td>534.00</td> </tr> <tr> <td>4"</td> <td>750.00</td> </tr> </table> <p><b>ADD FOR OPTIONS:</b></p> <table border="1"> <tr> <td>-1 (2" - 3") .....</td><td>\$190.00</td> <td>-VP .....</td><td>\$66.00</td> </tr> <tr> <td>-1 (4") .....</td><td>448.00</td> <td>-61 (2") .....</td><td>Deduct 43.00</td> </tr> <tr> <td>-2 (2" - 3") .....</td><td>171.00</td> <td>-61 (3", 4") .....</td><td>Deduct 88.00</td> </tr> <tr> <td>-2 (4") .....</td><td>404.00</td> <td>-92 .....</td><td>224.00</td> </tr> <tr> <td>-15 .....</td><td>109.00</td> <td>-Z .....</td><td>0.00</td> </tr> </table>	PIPE SIZE	<b>38250A</b>	2"	\$389.00	3"	534.00	4"	750.00	-1 (2" - 3") .....	\$190.00	-VP .....	\$66.00	-1 (4") .....	448.00	-61 (2") .....	Deduct 43.00	-2 (2" - 3") .....	171.00	-61 (3", 4") .....	Deduct 88.00	-2 (4") .....	404.00	-92 .....	224.00	-15 .....	109.00	-Z .....	0.00																														
PIPE SIZE	<b>37830</b>																																																																																														
2" - 6"	\$937.00																																																																																														
-7 .....	\$277.00	-49 .....	\$69.00	-92 .....	\$409.00																																																																																										
-19 .....	505.00	-50 .....	69.00	-X .....	0.00																																																																																										
-20 .....	418.00	-66 .....	170.00	-Z .....	0.00																																																																																										
-21 Deduct	216.00	-69 .....	36.00																																																																																												
-22 Deduct	143.00	-84 .....	192.00																																																																																												
PIPE SIZE	<b>38250A</b>																																																																																														
2"	\$389.00																																																																																														
3"	534.00																																																																																														
4"	750.00																																																																																														
-1 (2" - 3") .....	\$190.00	-VP .....	\$66.00																																																																																												
-1 (4") .....	448.00	-61 (2") .....	Deduct 43.00																																																																																												
-2 (2" - 3") .....	171.00	-61 (3", 4") .....	Deduct 88.00																																																																																												
-2 (4") .....	404.00	-92 .....	224.00																																																																																												
-15 .....	109.00	-Z .....	0.00																																																																																												

<p><b>38420</b></p> 	<p><b>NON-CLOG WITH CLEANOUT &amp; BUCKET</b></p> <p><b>LIST PRICE</b></p> <table border="1"> <tr> <td>PIPE SIZE</td> <td><b>38420</b></td> </tr> <tr> <td>3", 4"</td> <td>\$7,346.00</td> </tr> </table> <p><b>ADD FOR OPTIONS:</b></p> <table> <tr> <td>-IGS.....\$8,746.00</td> <td>-C.....\$244.00</td> </tr> <tr> <td>-1.....1,835.00</td> <td>-60.....448.00</td> </tr> <tr> <td>-2.....1,650.00</td> <td>-84.....192.00</td> </tr> <tr> <td>-15.....112.00</td> <td>-92.....1,596.00</td> </tr> <tr> <td>-VP.....109.00</td> <td></td> </tr> </table>	PIPE SIZE	<b>38420</b>	3", 4"	\$7,346.00	-IGS.....\$8,746.00	-C.....\$244.00	-1.....1,835.00	-60.....448.00	-2.....1,650.00	-84.....192.00	-15.....112.00	-92.....1,596.00	-VP.....109.00		<p><b>38850</b></p> 	<p><b>22" X 14" TOP, INTERNAL DOME STRAINER</b></p> <p><b>LIST PRICE</b></p> <table border="1"> <tr> <td>PIPE SIZE</td> <td><b>38850</b></td> </tr> <tr> <td>3" - 6"</td> <td>\$2,825.00</td> </tr> </table> <p><b>ADD FOR OPTIONS:</b></p> <table> <tr> <td>-7.....\$908.00</td> <td>-92.....\$1,515.00</td> </tr> <tr> <td>-15.....112.00</td> <td>-X.....0.00</td> </tr> <tr> <td>-VP.....109.00</td> <td></td> </tr> </table>	PIPE SIZE	<b>38850</b>	3" - 6"	\$2,825.00	-7.....\$908.00	-92.....\$1,515.00	-15.....112.00	-X.....0.00	-VP.....109.00										
PIPE SIZE	<b>38420</b>																																			
3", 4"	\$7,346.00																																			
-IGS.....\$8,746.00	-C.....\$244.00																																			
-1.....1,835.00	-60.....448.00																																			
-2.....1,650.00	-84.....192.00																																			
-15.....112.00	-92.....1,596.00																																			
-VP.....109.00																																				
PIPE SIZE	<b>38850</b>																																			
3" - 6"	\$2,825.00																																			
-7.....\$908.00	-92.....\$1,515.00																																			
-15.....112.00	-X.....0.00																																			
-VP.....109.00																																				
<p><b>38620-40</b></p> 	<p><b>13" X 11" TOP WITH HINGED GRATE</b></p> <p><b>LIST PRICE</b></p> <table border="1"> <tr> <td>PIPE SIZE</td> <td><b>38620-40</b></td> </tr> <tr> <td>3"</td> <td>\$2,250.00</td> </tr> <tr> <td>4"</td> <td>2,481.00</td> </tr> </table> <p><b>ADD FOR OPTIONS:</b></p> <table> <tr> <td>-1 (3") .....\$676.00</td> <td>-VP.....\$66.00</td> <td>-60 (4") ..\$333.00</td> </tr> <tr> <td>-1 (4") .....734.00</td> <td>-33.....170.00</td> <td>-70..Deduct 76.00</td> </tr> <tr> <td>-2 (3") .....548.00</td> <td>-49.....69.00</td> <td>-84.....192.00</td> </tr> <tr> <td>-2 (4") .....605.00</td> <td>-50.....69.00</td> <td>-92.....878.00</td> </tr> <tr> <td>-7.....279.00</td> <td>-60 (3") .....306.00</td> <td></td> </tr> </table>	PIPE SIZE	<b>38620-40</b>	3"	\$2,250.00	4"	2,481.00	-1 (3") .....\$676.00	-VP.....\$66.00	-60 (4") ..\$333.00	-1 (4") .....734.00	-33.....170.00	-70..Deduct 76.00	-2 (3") .....548.00	-49.....69.00	-84.....192.00	-2 (4") .....605.00	-50.....69.00	-92.....878.00	-7.....279.00	-60 (3") .....306.00		<p><b>38930</b></p> 	<p><b>21" X 14½" TOP, CLEANOUT &amp; BUCKET</b></p> <p><b>LIST PRICE</b></p> <table border="1"> <tr> <td>PIPE SIZE</td> <td><b>38930</b></td> </tr> <tr> <td>3", 4"</td> <td>\$1,634.00</td> </tr> </table> <p><b>ADD FOR OPTIONS:</b></p> <table> <tr> <td>-7.....\$282.00</td> <td>-84.....\$192.00</td> </tr> <tr> <td>-15.....112.00</td> <td>-92.....735.00</td> </tr> <tr> <td>-VP.....68.00</td> <td>-X.....0.00</td> </tr> <tr> <td>-C.....180.00</td> <td></td> </tr> </table>	PIPE SIZE	<b>38930</b>	3", 4"	\$1,634.00	-7.....\$282.00	-84.....\$192.00	-15.....112.00	-92.....735.00	-VP.....68.00	-X.....0.00	-C.....180.00	
PIPE SIZE	<b>38620-40</b>																																			
3"	\$2,250.00																																			
4"	2,481.00																																			
-1 (3") .....\$676.00	-VP.....\$66.00	-60 (4") ..\$333.00																																		
-1 (4") .....734.00	-33.....170.00	-70..Deduct 76.00																																		
-2 (3") .....548.00	-49.....69.00	-84.....192.00																																		
-2 (4") .....605.00	-50.....69.00	-92.....878.00																																		
-7.....279.00	-60 (3") .....306.00																																			
PIPE SIZE	<b>38930</b>																																			
3", 4"	\$1,634.00																																			
-7.....\$282.00	-84.....\$192.00																																			
-15.....112.00	-92.....735.00																																			
-VP.....68.00	-X.....0.00																																			
-C.....180.00																																				
<p><b>38640</b></p> 	<p><b>13" X 11" TOP WITH BUCKET</b></p> <p><b>LIST PRICE</b></p> <table border="1"> <tr> <td>PIPE SIZE</td> <td><b>38640</b></td> </tr> <tr> <td>2" - 4"</td> <td>\$1,025.00</td> </tr> </table> <p><b>ADD FOR OPTIONS:</b></p> <table> <tr> <td>-1.....\$617.00</td> <td>-70.....Deduct \$73.00</td> </tr> <tr> <td>-2.....512.00</td> <td>-84.....192.00</td> </tr> <tr> <td>-7.....282.00</td> <td>-92.....459.00</td> </tr> <tr> <td>-VP.....68.00</td> <td>-X.....0.00</td> </tr> </table>	PIPE SIZE	<b>38640</b>	2" - 4"	\$1,025.00	-1.....\$617.00	-70.....Deduct \$73.00	-2.....512.00	-84.....192.00	-7.....282.00	-92.....459.00	-VP.....68.00	-X.....0.00	<p><b>OPTION DESCRIPTIONS</b></p> <ul style="list-style-type: none"> <li>-AE LEVELEZE® Adjustable Extension</li> <li>-ARE Acid Resisting Epoxy</li> <li>-C Bolted Flashing Clamp Device</li> <li>-IGS Internal Gas Seal</li> <li>-LF Less Double Drainage Flange</li> <li>-LG Less Grate, Cast Iron</li> <li>-LG-1 Less Grate, Nikaloy</li> <li>-LG-2 Less Grate, Bronze</li> <li>-VP Secured Grate, Vandal-Proof Screws</li> <li>-1 Satin Finish Nikaloy Top</li> <li>-2 Satin Finish Bronze Top</li> <li>-4 Secondary Flashing Clamp (use with -AE only)</li> <li>-7 Ductile Iron Grate</li> <li>-11 Extra-Heavy Grate, Cast Iron</li> <li>-14 Hinged Grate</li> <li>-15 Chained Grate</li> <li>-18 Hinged Grate with Latching Device</li> <li>-19 C.I. Undergrate with Satin Finish Nikaloy Top</li> <li>-20 C.I. Undergrate with Satin Finish Bronze Top</li> <li>-21 Loose-Set Grate</li> <li>-22 Less Latching Device</li> <li>-33 Galvanized Bucket Only</li> <li>-49 3/4" Primer Tap</li> <li>-50 1/2" Primer Tap</li> <li>-51 1-1/2" Auxiliary Threaded Inlet</li> <li>-52 2" Auxiliary Threaded Inlet</li> <li>-60 Backwater Valve</li> <li>-61 Less Backwater Valve</li> <li>-69 Lift Handle for Sediment Bucket</li> <li>-70 Less Bucket</li> <li>-74 Aluminum Bucket</li> <li>-81 Slotted Cast Iron Bucket</li> <li>-81-92 Slotted Cast Iron Bucket, Galvanized</li> <li>-84 Stainless Steel Mesh Bucket Liner</li> <li>-88 Supplementary Strainer</li> <li>-92 Galvanized Cast Iron Parts</li> <li>-92-LF Galv. C.I. Parts, Less Double Drainage Flange</li> <li>-92-LG-LF Galv. C.I. Parts, Less Grate and Flange</li> </ul> <p><b>Outlets</b></p> <ul style="list-style-type: none"> <li>-66 No-Hub Side Outlet</li> <li>-T Threaded Outlet</li> <li>-X Inside Caulk Outlet</li> <li>-Y Hub Outlet with Gasket, 2" - 4"</li> <li>-Z No-Hub Outlet</li> </ul>																						
PIPE SIZE	<b>38640</b>																																			
2" - 4"	\$1,025.00																																			
-1.....\$617.00	-70.....Deduct \$73.00																																			
-2.....512.00	-84.....192.00																																			
-7.....282.00	-92.....459.00																																			
-VP.....68.00	-X.....0.00																																			
<p><b>38820</b></p> 	<p><b>15" X 13" TOP, TRACTOR GRATE</b></p> <p><b>LIST PRICE</b></p> <table border="1"> <tr> <td>PIPE SIZE</td> <td><b>38820</b></td> </tr> <tr> <td>3", 4"</td> <td>\$1,590.00</td> </tr> </table> <p><b>ADD FOR OPTIONS:</b></p> <table> <tr> <td>-1.....\$674.00</td> <td>-49.....\$69.00</td> <td>-84.....\$192.00</td> </tr> <tr> <td>-2.....608.00</td> <td>-50.....69.00</td> <td>-92.....427.00</td> </tr> <tr> <td>-7.....277.00</td> <td>-66.....170.00</td> <td>-X.....0.00</td> </tr> <tr> <td>-15.....112.00</td> <td>-74.....171.00</td> <td>-Z.....0.00</td> </tr> </table>	PIPE SIZE	<b>38820</b>	3", 4"	\$1,590.00	-1.....\$674.00	-49.....\$69.00	-84.....\$192.00	-2.....608.00	-50.....69.00	-92.....427.00	-7.....277.00	-66.....170.00	-X.....0.00	-15.....112.00	-74.....171.00	-Z.....0.00																			
PIPE SIZE	<b>38820</b>																																			
3", 4"	\$1,590.00																																			
-1.....\$674.00	-49.....\$69.00	-84.....\$192.00																																		
-2.....608.00	-50.....69.00	-92.....427.00																																		
-7.....277.00	-66.....170.00	-X.....0.00																																		
-15.....112.00	-74.....171.00	-Z.....0.00																																		
<p><b>38830</b></p> 	<p><b>13-3/4" X 14-1/8" TOP WITH HINGED GRATE</b></p> <p><b>LIST PRICE</b></p> <table border="1"> <tr> <td>PIPE SIZE</td> <td><b>38830</b></td> </tr> <tr> <td>3", 4"</td> <td>\$1,700.00</td> </tr> </table> <p><b>ADD FOR OPTIONS:</b></p> <table> <tr> <td>-1.....\$505.00</td> <td>-49.....\$69.00</td> </tr> <tr> <td>-2.....376.00</td> <td>-50.....69.00</td> </tr> <tr> <td>-7.....282.00</td> <td>-84.....192.00</td> </tr> <tr> <td>-VP.....66.00</td> <td>-92.....671.00</td> </tr> </table>	PIPE SIZE	<b>38830</b>	3", 4"	\$1,700.00	-1.....\$505.00	-49.....\$69.00	-2.....376.00	-50.....69.00	-7.....282.00	-84.....192.00	-VP.....66.00	-92.....671.00																							
PIPE SIZE	<b>38830</b>																																			
3", 4"	\$1,700.00																																			
-1.....\$505.00	-49.....\$69.00																																			
-2.....376.00	-50.....69.00																																			
-7.....282.00	-84.....192.00																																			
-VP.....66.00	-92.....671.00																																			

	<b>SQUARE CAN WASH DRAIN</b> LIST PRICE			<b>CAST STAINLESS STEEL</b> ADJUSTABLE FLOOR DRAIN WITH ROUND SUPER-FLO® STRAINER LIST PRICE		
	PIPE SIZE	39240		PIPE SIZE	30000-A-SS-T	
	3" - 4"	\$1,297.00		2"	POA*	
ADD FOR OPTIONS:				3"	POA*	
-1	\$365.00	-C	\$0.00	-92	\$475.00	
-2	\$321.00	-66	\$170.00	-X	\$0.00	
-15	\$112.00	-84	\$216.00	-Z	\$0.00	
	<b>PLANTING AREA DRAIN</b> LIST PRICE			ADJUSTABLE FLOOR DRAIN WITH SQUARE SUPER-FLO® STRAINER LIST PRICE		
	PIPE SIZE	39600		PIPE SIZE	30000-S-SS-T	
	2" - 6"	\$502.00		2"	POA*	
ADD FOR OPTIONS:				3"	POA*	
-66	\$170.00	-92	\$180.00	-X	\$0.00	
-89	\$69.00	-T	\$36.00	-Z	\$0.00	
	<b>11" TOP COMPOSITION DECK FLANGE</b> LIST PRICE			ADJUSTABLE FLOOR DRAIN WITH SQUARE SUPER-FLO® STRAINER LIST PRICE		
	PIPE SIZE	39720		PIPE SIZE	30000-S-SS-T	
	2" - 4"	\$928.00		2"	POA*	
ADD FOR OPTIONS:				3"	POA*	
-1	\$347.00	-13-1	\$571.00	-70	Ded. \$143.00	
-2	\$302.00	-13-2	\$489.00	-92	\$418.00	
-7	\$121.00	-15	\$112.00	-T	\$36.00	
-13	\$63.00	-VP	\$68.00	-X	\$0.00	
	<b>8" SQUARE TOP WITH HINGED GRATE</b> LIST PRICE			ROUND SUPER-FLO® TOP WITH ADJUSTABLE EXTENSION LIST PRICE		
	PIPE SIZE	39960		PIPE SIZE	32100-SS-AE	
	2"	\$175.00		2"	POA*	
	3"	213.00		3"	POA*	
	4"	365.00		4"	POA*	
ADD FOR OPTIONS:			ADD FOR OPTIONS:			
-VP	\$68.00	-92	\$150.00	-1	*POA	
-ARE	\$184.00	-X	\$0.00	-8	*POA	
				-22	*POA	
				-25	*POA	
				-61	*POA	
				-69	STD	
				-9	*POA	
				-26	*POA	
				-81	*POA	
				-21	*POA	
				-34	*POA	
				* PRICE ON APPLICATION		
<b>Floor Drain OPTION DESCRIPTIONS</b>				ROUND 12" TOP LIST PRICE		
-ARE	Acid Resisting Epoxy			PIPE SIZE	32200-SS	
-C	Bolted Flashing Clamp Device			3"	POA*	
-VP	Secured Grate, Vandal-Proof Screws			4"	POA*	
-1	Satin Finish Nikaloy Top			6"	POA*	
-2	Satin Finish Bronze Top		ADD FOR OPTIONS:			
-7	Ductile Iron Grate		-8	*POA	-25	*POA
-13	Dome Grate, Cast Iron		-9	*POA	-26	*POA
-13-1	Dome Grate, Nikaloy		-22	*POA	-34	*POA
-13-2	Dome Grate, Bronze		* PRICE ON APPLICATION			
-15	Chained Grate		<b>CLEANOUT</b> LIST PRICE			
-70	Less Bucket		PIPE SIZE	56670-SS		
-84	Stainless Steel Mesh Bucket Liner			2"	POA*	
-89	Deck Clamp Assembly			3"	POA*	
-92	Galvanized Cast Iron Parts			4"	POA*	
				6"	POA*	
<b>Outlets</b>			ADD FOR OPTIONS:			
-66	No-Hub Side Outlet		-45	*POA	-67	*POA
-T	Threaded Outlet		-69	STD		
-X	Inside Caulk Outlet		* PRICE ON APPLICATION			
-Z	No-Hub Outlet					

### Cast Stainless Steel OPTION DESCRIPTIONS

- 5A-SS 5" Round Stainless Steel Strainer
- 6A-SS 6" Round Stainless Steel Strainer
- 7A-SS 7" Round Stainless Steel Strainer
- 8A-SS 8" Round Stainless Steel Strainer
- 5S-SS 5" Square Stainless Steel Strainer
- 6S-SS 6" Square Stainless Steel Strainer
- 8S-SS 8" Square Stainless Steel Strainer
- VP Secured Grate, Vandal-Proof Screws
- 1 Satin Finish Nikaloy Grate
- 8 Solid Cover (Specify Material)
- 9 Stainless Steel Mesh Screen on Underside of Grate
- 21 4" Diameter Funnel (Same Material as Grate)
- 22 6" Diameter Funnel (Same Material as Grate)
- 25 Type 304 Stainless Steel Recessed Closure Plug
- 26 Molded ABS Recessed Closure Plug
- 34 "T" Handle for Recessed Plug
- 45 Spanner Wrench
- 50 1/2" Primer Tap
- 61 Flashing Clamp Device
- 80 Perforated Stainless Steel Basket
- 81 Shallow Stainless Steel Sediment Bucket

**Outlets:**

- 69 Schedule 10 S Butt Weld Connection
- T Threaded Outlet

**40340**



**NEW**

**FLOOR DRAIN/FLOOR SINK,  
12" X 12" PERFORATED GRATE, 8" DEEP**

**LIST PRICE**

PIPE SIZE	2", 3", 4"	POA*
-----------	------------	------

**ADD FOR OPTIONS:**

-MD .....	*POA	-B .....	*POA
-PF .....	*POA	-Y (2", 3") .....	*POA
-XHD .....	*POA	-Y (3", 4") .....	*POA
-CG.....	*POA		

\*PRICE ON APPLICATION

Will be Available May, 2008

**40460**

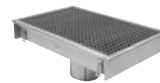

**NEW**

**20" X 20" KETTLE DRAIN WITH MESH GRATE**

**LIST PRICE**

PIPE SIZE	Nom. 4", 6"	POA*
-----------	-------------	------

**ADD FOR OPTIONS:**

-B .....	*POA	-Z** .....	*POA
-WT .....	*POA		

\* PRICE ON APPLICATION

\*\* No-Hub with Transitional Coupling

**40520**



**NEW**

**FLOOR DRAIN/FLOOR SINK,  
8" ROUND PERFORATED GRATE**

**LIST PRICE**

PIPE SIZE	Nom. 3", 4"	POA*
-----------	-------------	------

**ADD FOR OPTIONS:**

-MD .....	*POA	-B .....	*POA
-PF .....	*POA	-SO .....	*POA
-XHD .....	*POA	-WT .....	*POA
-CG.....	*POA	-Z** .....	*POA

\* PRICE ON APPLICATION

\*\* No-Hub with Transitional Coupling

**40580**



**NEW**

**FLOOR DRAIN/FLOOR SINK,  
12" ROUND PERFORATED GRATE**

**LIST PRICE**

PIPE SIZE	Nom. 3", 4"	POA*
-----------	-------------	------

**ADD FOR OPTIONS:**

-MD .....	*POA	-B .....	*POA
-PF .....	*POA	-SO .....	*POA
-XHD .....	*POA	-WT .....	*POA
-CG.....	*POA	-Z** .....	*POA

\* PRICE ON APPLICATION

\*\* No-Hub with Transitional Coupling

## FABRICATED STAINLESS STEEL

**40300**



**NEW**

**FLOOR DRAIN/FLOOR SINK,  
8" X 8" PERFORATED GRATE**

**LIST PRICE**

PIPE SIZE	Nom. 3", 4"	POA*
-----------	-------------	------

**ADD FOR OPTIONS:**

-MD .....	*POA	-B .....	*POA
-PF .....	*POA	-SO .....	*POA
-XHD .....	*POA	-WT .....	*POA
-CG.....	*POA	-Z** .....	*POA

\* PRICE ON APPLICATION

\*\* No-Hub with Transitional Coupling

**40320**



**NEW**

**FLOOR DRAIN/FLOOR SINK,  
12" X 12" PERFORATED GRATE, 6" DEEP**

**LIST PRICE**

PIPE SIZE	2", 3", 4"	POA*
-----------	------------	------

**ADD FOR OPTIONS:**

-MD .....	*POA	-B .....	*POA
-PF .....	*POA	-Y (2", 3") .....	*POA
-XHD .....	*POA	-Z (3", 4") .....	*POA
-CG.....	*POA		

\*PRICE ON APPLICATION

Will be Available May, 2008

### Fabricated Stainless Steel OPTION DESCRIPTIONS



- B Stainless Steel Bucket
- CG Cast Stainless Steel Grate
- MD Medium-Duty Mesh Grate
- PF Heavy-Duty Perimeter Slot Grate
- WT With Trap
- XHD Extra Heavy-Duty Bar Grate





**Outlets:**

- SO Side Outlet
- Y Hub Outlet with Gasket
- Z No-Hub Outlet

# SANITARY FLOOR SINKS



	<b>49300</b>				<b>SUPER-FLO® 8" SQUARE TOP, 6" DEEP</b>					
	<b>LIST PRICE</b>									
	PIPE SIZE	49300	49300 -LF	49300 -NB	49300 -LF-NB	PIPE SIZE	49360A	49360A -LF	49360A -NB	49360A -LF-NB
	2" - 4"	\$809.00	\$725.00	\$1,006.00	\$922.00	2" - 4"	\$1,258.00	\$1,081.00	\$1,605.00	\$1,428.00
<b>ADD FOR OPTIONS:</b>										
-LF .....Deduct \$84.00      -18 (ARE) .....\$243.00 -NB .....197.00                -18 (NB) .....405.00 -LG (ARE) .....Deduct 87.00      -20 (NB) .....103.00 -LG (NB) .....Deduct 139.00      -24 (NB) .....99.00 -3 .....0.00                        -31 .....92.00 -4 .....0.00                        -33 .....197.00 -7 .....81.00                       -35* .....216.00 -8 .....87.00                       -43 .....144.00 -VP (NB) .....35.00               -45 .....Deduct 27.00 -16 (ARE) .....174.00              -55** .....87.00 -16 (NB) .....195.00              -C .....68.00 -17 (ARE) .....224.00              -X .....0.00 -17 (NB) .....288.00              -Z .....0.00					-LF .....Deduct \$177.00      -17 (NB) .....\$288.00 -NB .....347.00                -18 (ARE) .....243.00 -LG (ARE) .....Deduct 104.00      -18 (NB) .....405.00 -LG (NB) .....Deduct 226.00      -20 (NB) .....103.00 -3 .....0.00                       -24 (NB) .....99.00 -4 .....0.00                       -31 .....144.00 -5 .....501.00                       -32 .....144.00 -7 .....81.00                       -33 .....276.00 -8 .....87.00                       -35* .....216.00 -VP (NB) .....35.00               -43 .....155.00 -15 .....1,611.00                  -45 .....Deduct 27.00 -16 (ARE) .....174.00              -55** .....87.00 -16 (NB) .....195.00              -C .....86.00 -17 (ARE) .....224.00              -X .....0.00 -17 (NB) .....288.00              -Y .....0.00 -Z .....0.00					
* Specify -31 or -33 Bucket					* Specify -31 or -33 Bucket					
** 88450 Provided					** 88450 Provided					
	<b>49320A</b>				<b>12" SQUARE TOP, 6" DEEP</b>					
	<b>LIST PRICE</b>									
	PIPE SIZE	49320A	49320A -LF	49320A -NB	49320A -LF-NB	PIPE SIZE	49400	49400 -LF	49400 -NB	49400 -LF-NB
	2", 3" 4", 6"	\$1,150.00	\$973.00	\$1,497.00	\$1,320.00	3", 4", 6"	\$2,160.00	\$1,990.00	\$2,721.00	\$2,551.00
<b>ADD FOR OPTIONS:</b>										
-LF (2" - 4")..Deduct \$177.00      -17 (NB) .....\$288.00 -NB .....347.00                -18 (ARE) .....243.00 -LG (ARE) .....Deduct 104.00      -18 (NB) .....405.00 -LG (NB) .....Deduct 226.00      -20 (NB) .....103.00 -3 .....0.00                       -24 (NB) .....99.00 -4 .....0.00                       -31 .....144.00 -5 .....501.00                       -33 .....276.00 -7 .....81.00                       -35* .....216.00 -8 .....87.00                       -43 .....155.00 -VP (NB) .....35.00               -45 .....Deduct 27.00 -15 .....1,611.00                  -55** .....87.00 -16 (ARE) .....174.00              -C .....86.00 -16 (NB) .....195.00              -X .....0.00 -17 (ARE) .....224.00              -Y (2" - 4") .....0.00 -17 (NB) .....288.00              -Z .....0.00					-LF .....Deduct \$170.00      -17 (NB) .....\$288.00 -NB .....561.00                -18 (ARE) .....243.00 -LG (ARE) .....Deduct 172.00      -18 (NB) .....404.00 -LG (NB) .....Deduct 478.00      -31 .....382.00 -3 .....0.00                       -33 .....1,075.00 -4 .....0.00                       -35* .....432.00 -7 .....81.00                       -43 .....144.00 -8 .....87.00                       -45 .....Deduct 27.00 -VP (NB) .....35.00               -51 .....See 37960 Series -16 (ARE) .....174.00              -52 .....See 37960 Series -16 (NB) .....195.00              -55** .....87.00 -17 (ARE) .....224.00              -C .....258.00 -17 (NB) .....288.00              -X .....0.00					
* Specify -31 or -33 Bucket					* Specify -31 or -33 Bucket					
** 88450 Provided for 2" - 4". Body Primer Tapped for 6".					** 88450 Provided for 3" & 4". Body Primer Tapped for 6".					
	<b>49340A</b>				<b>12" SQUARE TOP, 8" DEEP</b>					
	<b>LIST PRICE</b>									
	PIPE SIZE	49340A	49340A -LF	49340A -NB	49340A -LF-NB	PIPE SIZE	49420	49420 -LF	49420 -NB	49420 -LF-NB
	2" - 4"	\$1,198.00	\$1,021.00	\$1,545.00	\$1,368.00	3", 4", 6"	\$2,160.00	\$1,930.00	\$2,721.00	\$2,491.00
<b>ADD FOR OPTIONS:</b>										
-LF .....Ded. \$177.00                -17 (ARE) .....\$224.00 -NB .....347.00                -17 (NB) .....288.00 -LG (ARE) .....Deduct 104.00      -18 (ARE) .....243.00 -LG (NB) .....Deduct 226.00      -18 (NB) .....405.00 -3 .....0.00                       -20 (NB) .....103.00 -4 .....0.00                       -24 (NB) .....99.00 -5 .....501.00                       -31 .....144.00 -7 .....81.00                       -33 .....276.00 -8 .....87.00                       -35* .....216.00 -VP (NB) .....35.00               -43 .....155.00 -15 .....1,611.00                  -45 .....Deduct 27.00 -16 (ARE) .....174.00              -55** .....87.00 -16 (NB) .....195.00              -C .....86.00 -17 (ARE) .....224.00              -X .....0.00 -17 (NB) .....288.00              -Y .....0.00 -Z .....0.00					-LF .....Deduct \$230.00                -17 (NB) .....\$288.00 -NB .....561.00                -18 (ARE) .....243.00 -LG (ARE) .....Deduct 172.00      -18 (NB) .....404.00 -LG (NB) .....Deduct 478.00      -31 .....382.00 -3 .....0.00                       -33 .....1,075.00 -4 .....0.00                       -35* .....432.00 -7 .....81.00                       -43 .....144.00 -8 .....87.00                       -45 .....Deduct 27.00 -VP (NB) .....35.00               -51 .....0.00 -16 (ARE) .....174.00              -52 .....Deduct 172.00 -16 (NB) .....195.00              -55** .....87.00 -17 (ARE) .....224.00              -C .....258.00 -17 (NB) .....288.00              -X .....0.00					
* Specify -31 or -33 Bucket					* Specify -31 or -33 Bucket					
** 88450 Provided					** 88450 Provided for 3" & 4". Body Primer Tapped for 6".					

<p><b>49500</b></p> 	<p><b>SUPER-FLO® 8" ROUND TOP, 3" DEEP</b></p> <p><b>LIST PRICE</b></p> <table border="1"> <thead> <tr> <th>PIPE SIZE</th> <th>49500</th> <th>49500 -LF</th> <th>49500 -NB</th> <th>49500 -LF-NB</th> </tr> </thead> <tbody> <tr> <td>2" - 4"</td> <td>\$718.00</td> <td>\$587.00</td> <td>\$831.00</td> <td>\$700.00</td> </tr> </tbody> </table> <p><b>ADD FOR OPTIONS:</b></p> <table border="0"> <tr> <td>-LF .....Deduct \$131.00</td> <td>-18 (ARE) .....\$243.00</td> </tr> <tr> <td>-NB.....113.00</td> <td>-18 (NB) .....404.00</td> </tr> <tr> <td>-LG (ARE).....Deduct 87.00</td> <td>-31 .....103.00</td> </tr> <tr> <td>-LG (NB).....Deduct 95.00</td> <td>-33 .....249.00</td> </tr> <tr> <td>-3 .....0.00</td> <td>-35* .....216.00</td> </tr> <tr> <td>-4 .....0.00</td> <td>-43 .....144.00</td> </tr> <tr> <td>-7 .....81.00</td> <td>-45 .....Deduct 27.00</td> </tr> <tr> <td>-8 .....86.00</td> <td>-51 .....0.00</td> </tr> <tr> <td>-VP (NB).....35.00</td> <td>-52 .....Deduct 81.00</td> </tr> <tr> <td>-16 (ARE) .....174.00</td> <td>-55** .....87.00</td> </tr> <tr> <td>-16 (NB) .....195.00</td> <td>-C .....86.00</td> </tr> <tr> <td>-17 (ARE) .....224.00</td> <td>-X .....0.00</td> </tr> <tr> <td>-17 (NB) .....288.00</td> <td></td> </tr> </table> <p>* Specify -31 or -33 Bucket ** 88450 Provided</p>	PIPE SIZE	49500	49500 -LF	49500 -NB	49500 -LF-NB	2" - 4"	\$718.00	\$587.00	\$831.00	\$700.00	-LF .....Deduct \$131.00	-18 (ARE) .....\$243.00	-NB.....113.00	-18 (NB) .....404.00	-LG (ARE).....Deduct 87.00	-31 .....103.00	-LG (NB).....Deduct 95.00	-33 .....249.00	-3 .....0.00	-35* .....216.00	-4 .....0.00	-43 .....144.00	-7 .....81.00	-45 .....Deduct 27.00	-8 .....86.00	-51 .....0.00	-VP (NB).....35.00	-52 .....Deduct 81.00	-16 (ARE) .....174.00	-55** .....87.00	-16 (NB) .....195.00	-C .....86.00	-17 (ARE) .....224.00	-X .....0.00	-17 (NB) .....288.00		<p><b>49700</b></p> 	<p><b>4" X 8" RECTANGULAR TOP, 4" DEEP</b></p> <p><b>LIST PRICE</b></p> <table border="1"> <thead> <tr> <th>PIPE SIZE</th> <th>49700</th> <th>49700 -LF</th> <th>49700 -NB</th> <th>49700 -LF-NB</th> </tr> </thead> <tbody> <tr> <td>2", 3"</td> <td>\$837.00</td> <td>\$750.00</td> <td>\$987.00</td> <td>\$900.00</td> </tr> </tbody> </table> <p><b>ADD FOR OPTIONS:</b></p> <table border="0"> <tr> <td>-LF .....Deduct \$87.00</td> <td>-16 (NB) .....\$195.00</td> </tr> <tr> <td>-NB.....150.00</td> <td>-30 .....216.00</td> </tr> <tr> <td>-LG (ARE).....Deduct 69.00</td> <td>-43 .....144.00</td> </tr> <tr> <td>-LG (NB).....Deduct 138.00</td> <td>-45 .....Deduct 27.00</td> </tr> <tr> <td>-3 .....0.00</td> <td>-51 .....0.00</td> </tr> <tr> <td>-4 .....0.00</td> <td>-52 .....Deduct 76.00</td> </tr> <tr> <td>-7 .....81.00</td> <td>-55* .....87.00</td> </tr> <tr> <td>-8 .....87.00</td> <td>-C .....86.00</td> </tr> <tr> <td>-VP (NB).....35.00</td> <td>-X .....0.00</td> </tr> <tr> <td>-16 (ARE) .....174.00</td> <td></td> </tr> </table> <p>* 88450 Provided</p>	PIPE SIZE	49700	49700 -LF	49700 -NB	49700 -LF-NB	2", 3"	\$837.00	\$750.00	\$987.00	\$900.00	-LF .....Deduct \$87.00	-16 (NB) .....\$195.00	-NB.....150.00	-30 .....216.00	-LG (ARE).....Deduct 69.00	-43 .....144.00	-LG (NB).....Deduct 138.00	-45 .....Deduct 27.00	-3 .....0.00	-51 .....0.00	-4 .....0.00	-52 .....Deduct 76.00	-7 .....81.00	-55* .....87.00	-8 .....87.00	-C .....86.00	-VP (NB).....35.00	-X .....0.00	-16 (ARE) .....174.00	
PIPE SIZE	49500	49500 -LF	49500 -NB	49500 -LF-NB																																																																	
2" - 4"	\$718.00	\$587.00	\$831.00	\$700.00																																																																	
-LF .....Deduct \$131.00	-18 (ARE) .....\$243.00																																																																				
-NB.....113.00	-18 (NB) .....404.00																																																																				
-LG (ARE).....Deduct 87.00	-31 .....103.00																																																																				
-LG (NB).....Deduct 95.00	-33 .....249.00																																																																				
-3 .....0.00	-35* .....216.00																																																																				
-4 .....0.00	-43 .....144.00																																																																				
-7 .....81.00	-45 .....Deduct 27.00																																																																				
-8 .....86.00	-51 .....0.00																																																																				
-VP (NB).....35.00	-52 .....Deduct 81.00																																																																				
-16 (ARE) .....174.00	-55** .....87.00																																																																				
-16 (NB) .....195.00	-C .....86.00																																																																				
-17 (ARE) .....224.00	-X .....0.00																																																																				
-17 (NB) .....288.00																																																																					
PIPE SIZE	49700	49700 -LF	49700 -NB	49700 -LF-NB																																																																	
2", 3"	\$837.00	\$750.00	\$987.00	\$900.00																																																																	
-LF .....Deduct \$87.00	-16 (NB) .....\$195.00																																																																				
-NB.....150.00	-30 .....216.00																																																																				
-LG (ARE).....Deduct 69.00	-43 .....144.00																																																																				
-LG (NB).....Deduct 138.00	-45 .....Deduct 27.00																																																																				
-3 .....0.00	-51 .....0.00																																																																				
-4 .....0.00	-52 .....Deduct 76.00																																																																				
-7 .....81.00	-55* .....87.00																																																																				
-8 .....87.00	-C .....86.00																																																																				
-VP (NB).....35.00	-X .....0.00																																																																				
-16 (ARE) .....174.00																																																																					
<p><b>49520A</b></p> 	<p><b>SUPER-FLO® 8" ROUND TOP, 6" DEEP</b></p> <p><b>LIST PRICE</b></p> <table border="1"> <thead> <tr> <th>PIPE SIZE</th> <th>49520A</th> <th>49520A -LF</th> <th>49520A -NB</th> <th>49520A -LF-NB</th> </tr> </thead> <tbody> <tr> <td>2" - 4"</td> <td>\$739.00</td> <td>\$608.00</td> <td>\$948.00</td> <td>\$817.00</td> </tr> </tbody> </table> <p><b>ADD FOR OPTIONS:</b></p> <table border="0"> <tr> <td>-LF .....Deduct \$131.00</td> <td>-18 (ARE) .....\$243.00</td> </tr> <tr> <td>-NB.....209.00</td> <td>-18 (NB) .....404.00</td> </tr> <tr> <td>-LG (ARE).....Deduct 87.00</td> <td>-31 .....103.00</td> </tr> <tr> <td>-LG (NB).....Deduct 95.00</td> <td>-33 .....249.00</td> </tr> <tr> <td>-3 .....0.00</td> <td>-35* .....216.00</td> </tr> <tr> <td>-4 .....0.00</td> <td>-43 .....144.00</td> </tr> <tr> <td>-7 .....81.00</td> <td>-45 .....Deduct 27.00</td> </tr> <tr> <td>-8 .....86.00</td> <td>-51 .....0.00</td> </tr> <tr> <td>-VP (NB).....35.00</td> <td>-52 .....Deduct 76.00</td> </tr> <tr> <td>-16 (ARE) .....174.00</td> <td>-55** .....87.00</td> </tr> <tr> <td>-16 (NB) .....195.00</td> <td>-C .....86.00</td> </tr> <tr> <td>-17 (ARE) .....224.00</td> <td>-X .....0.00</td> </tr> <tr> <td>-17 (NB) .....288.00</td> <td></td> </tr> </table> <p>* Specify -31 or -33 Bucket ** 88450 Provided</p>	PIPE SIZE	49520A	49520A -LF	49520A -NB	49520A -LF-NB	2" - 4"	\$739.00	\$608.00	\$948.00	\$817.00	-LF .....Deduct \$131.00	-18 (ARE) .....\$243.00	-NB.....209.00	-18 (NB) .....404.00	-LG (ARE).....Deduct 87.00	-31 .....103.00	-LG (NB).....Deduct 95.00	-33 .....249.00	-3 .....0.00	-35* .....216.00	-4 .....0.00	-43 .....144.00	-7 .....81.00	-45 .....Deduct 27.00	-8 .....86.00	-51 .....0.00	-VP (NB).....35.00	-52 .....Deduct 76.00	-16 (ARE) .....174.00	-55** .....87.00	-16 (NB) .....195.00	-C .....86.00	-17 (ARE) .....224.00	-X .....0.00	-17 (NB) .....288.00		<p><b>OPTION DESCRIPTIONS</b></p> <ul style="list-style-type: none"> <li>-C Clamp Device</li> <li>-LF Less Flange</li> <li>-LG Less Grate</li> <li>-NB Nickel Bronze Traffic Top</li> <li>-VP Secured Grate, Vandal-Proof Screws</li> <li>-3 1/2 Grate</li> <li>-4 3/4 Grate</li> <li>-5 Nikaloy Extra Heavy-Duty Grate &amp; Rim (Not SUPER-FLO® Design)</li> <li>-7 Full Grate with 2-1/2" Center Opening</li> <li>-8 Stainless Steel Depressed Grate</li> <li>-15 Stainless Steel Rim and Grate</li> <li>-16 Grate with 4" Round Funnel</li> <li>-17 Grate with 6" Round Funnel</li> <li>-18 Grate with 9" x 3-1/2" Oval Funnel</li> <li>-20 Solid Nikaloy Cover</li> <li>-24 Chained Grate</li> <li>-30 Stainless Steel Sediment Bucket</li> <li>-31 Sediment Bucket (Aluminum)</li> <li>-33 Sediment Bucket (A.R. Finish)</li> <li>-35 Stainless Steel Mesh Bucket Liner</li> <li>-43 Internal Dome Strainer (A.R. Finish)</li> <li>-45 Less Internal Dome Strainer</li> <li>-51 Galvanized Cast Iron Inside and Outside</li> <li>-52 Painted Inside and Outside</li> <li>-55 1/2" Primer Tap or Adapter</li> </ul> <p><b>Outlets</b></p> <ul style="list-style-type: none"> <li>-X Inside Caulk Outlet</li> <li>-Z No-Hub Outlet</li> </ul>																															
PIPE SIZE	49520A	49520A -LF	49520A -NB	49520A -LF-NB																																																																	
2" - 4"	\$739.00	\$608.00	\$948.00	\$817.00																																																																	
-LF .....Deduct \$131.00	-18 (ARE) .....\$243.00																																																																				
-NB.....209.00	-18 (NB) .....404.00																																																																				
-LG (ARE).....Deduct 87.00	-31 .....103.00																																																																				
-LG (NB).....Deduct 95.00	-33 .....249.00																																																																				
-3 .....0.00	-35* .....216.00																																																																				
-4 .....0.00	-43 .....144.00																																																																				
-7 .....81.00	-45 .....Deduct 27.00																																																																				
-8 .....86.00	-51 .....0.00																																																																				
-VP (NB).....35.00	-52 .....Deduct 76.00																																																																				
-16 (ARE) .....174.00	-55** .....87.00																																																																				
-16 (NB) .....195.00	-C .....86.00																																																																				
-17 (ARE) .....224.00	-X .....0.00																																																																				
-17 (NB) .....288.00																																																																					
<p><b>49580A</b></p> 	<p><b>SUPER-FLO® 12" ROUND TOP, 8" DEEP</b></p> <p><b>LIST PRICE</b></p> <table border="1"> <thead> <tr> <th>PIPE SIZE</th> <th>49580A</th> <th>49580A -LF</th> <th>49580A -NB</th> <th>49580A -LF-NB</th> </tr> </thead> <tbody> <tr> <td>2" - 4"</td> <td>\$945.00</td> <td>\$773.00</td> <td>\$1,405.00</td> <td>\$1,233.00</td> </tr> </tbody> </table> <p><b>ADD FOR OPTIONS:</b></p> <table border="0"> <tr> <td>-LF .....Deduct \$172.00</td> <td>-18 (ARE) .....\$243.00</td> </tr> <tr> <td>-NB.....460.00</td> <td>-18 (NB) .....404.00</td> </tr> <tr> <td>-LG (ARE).....Deduct 120.00</td> <td>-31 .....144.00</td> </tr> <tr> <td>-LG (NB).....Deduct 234.00</td> <td>-33 .....216.00</td> </tr> <tr> <td>-3 .....0.00</td> <td>-35* .....216.00</td> </tr> <tr> <td>-4 .....0.00</td> <td>-43 .....144.00</td> </tr> <tr> <td>-7 .....81.00</td> <td>-45 .....Deduct 27.00</td> </tr> <tr> <td>-8 .....87.00</td> <td>-51 .....0.00</td> </tr> <tr> <td>-VP (NB).....35.00</td> <td>-52 .....Deduct 131.00</td> </tr> <tr> <td>-16 (ARE) .....174.00</td> <td>-55** .....87.00</td> </tr> <tr> <td>-16 (NB) .....195.00</td> <td>-C .....86.00</td> </tr> <tr> <td>-17 (ARE) .....224.00</td> <td>-X .....0.00</td> </tr> <tr> <td>-17 (NB) .....288.00</td> <td>-Z .....0.00</td> </tr> </table> <p>* Specify -31 or -33 Bucket ** 88450 Provided</p>	PIPE SIZE	49580A	49580A -LF	49580A -NB	49580A -LF-NB	2" - 4"	\$945.00	\$773.00	\$1,405.00	\$1,233.00	-LF .....Deduct \$172.00	-18 (ARE) .....\$243.00	-NB.....460.00	-18 (NB) .....404.00	-LG (ARE).....Deduct 120.00	-31 .....144.00	-LG (NB).....Deduct 234.00	-33 .....216.00	-3 .....0.00	-35* .....216.00	-4 .....0.00	-43 .....144.00	-7 .....81.00	-45 .....Deduct 27.00	-8 .....87.00	-51 .....0.00	-VP (NB).....35.00	-52 .....Deduct 131.00	-16 (ARE) .....174.00	-55** .....87.00	-16 (NB) .....195.00	-C .....86.00	-17 (ARE) .....224.00	-X .....0.00	-17 (NB) .....288.00	-Z .....0.00																																
PIPE SIZE	49580A	49580A -LF	49580A -NB	49580A -LF-NB																																																																	
2" - 4"	\$945.00	\$773.00	\$1,405.00	\$1,233.00																																																																	
-LF .....Deduct \$172.00	-18 (ARE) .....\$243.00																																																																				
-NB.....460.00	-18 (NB) .....404.00																																																																				
-LG (ARE).....Deduct 120.00	-31 .....144.00																																																																				
-LG (NB).....Deduct 234.00	-33 .....216.00																																																																				
-3 .....0.00	-35* .....216.00																																																																				
-4 .....0.00	-43 .....144.00																																																																				
-7 .....81.00	-45 .....Deduct 27.00																																																																				
-8 .....87.00	-51 .....0.00																																																																				
-VP (NB).....35.00	-52 .....Deduct 131.00																																																																				
-16 (ARE) .....174.00	-55** .....87.00																																																																				
-16 (NB) .....195.00	-C .....86.00																																																																				
-17 (ARE) .....224.00	-X .....0.00																																																																				
-17 (NB) .....288.00	-Z .....0.00																																																																				

	<b>6" X 12" RECTANGULAR TOP, 7" DEEP</b>			
	<b>LIST PRICE</b>			
<b>PIPE SIZE</b>	<b>49720</b>	<b>49720 -LF</b>	<b>49720 -NB</b>	<b>49720 -LF-NB</b>
3", 4", 6"	\$1,114.00	\$987.00	\$1,338.00	\$1,211.00
<b>ADD FOR OPTIONS:</b>				
-LF .....	Deduct \$127.00	-18 (ARE) .....	\$243.00	
-NB .....	224.00	-18 (NB) .....	403.00	
-LG (ARE) .....	Deduct 87.00	-30 .....	216.00	
-LG (NB) .....	Deduct 155.00	-43 .....	144.00	
-3 .....	0.00	-45 .....	Deduct 27.00	
-4 .....	0.00	-51 .....	0.00	
-7 .....	81.00	-52 .....	Deduct 131.00	
-8 .....	87.00	-55* .....	87.00	
-VP .....	35.00	-C .....	86.00	
-16 (ARE) .....	174.00	-X .....	0.00	
-16 (NB) .....	195.00			
* 88450 Provided for 3" & 4". Body Primer Tapped for 6".				

	<b>12" ROUND FLUSHING RIM TOP</b>		
	<b>LIST PRICE</b>		
<b>PIPE SIZE</b>	<b>49850</b>		
2"*, 3"*, 4", 6"	\$1,200.00		
<b>ADD FOR OPTIONS:</b>			
-VP .....	\$0.00	-98 .....	\$2,576.00
-13 .....	45.00	-C .....	87.00
-14 .....	132.00	-X .....	0.00
-51 .....	0.00	-Z (6") .....	0.00
*The 49852 and 49853 use a 49854 Body with a Reducing Coupling.			





	<b>12" SQUARE CAN WASH DRAIN</b>		
	<b>LIST PRICE</b>		
<b>PIPE SIZE</b>	<b>49870A</b>		
3", 4"	\$2,335.00		
<b>ADD FOR OPTIONS:</b>			
-VP .....	\$35.00	-98 .....	\$2,576.00
-35 .....	135.00	-C .....	86.00
-51 .....	0.00	-X .....	0.00
-55* .....	87.00	-Z .....	0.00
* 88450 Provided			

## Sanitary Floor Sink OPTION DESCRIPTIONS

- C Clamp Device
- LF Less Flange
- LG Less Grate
- NB Nickel Bronze Traffic Top
- VP Secured Grate, Vandal-Proof Screws
- 3 1/2 Grate
- 4 3/4 Grate
- 7 Full Grate with 2-1/2" Center Opening
- 8 Stainless Steel Depressed Grate
- 13 One-Piece Satin Nikaloy Grate
- 14 Loose-Set Satin Nikaloy Grate
- 16 Grate with 4" Round Funnel
- 18 Grate with 9" x 3-1/2" Oval Funnel
- 30 Stainless Steel Sediment Bucket
- 35 Stainless Steel Mesh Bucket Liner
- 43 Internal Dome Strainer (A.R. Finish)
- 45 Less Internal Dome Strainer
- 51 Galvanized Cast Iron Inside and Outside
- 52 Painted Inside and Outside
- 55 1/2" Primer Tap or Adapter
- 98 Water Supply Control Box

### Outlets

- X Inside Caulk Outlet
- Z No-Hub Outlet

<b>55000</b> 	<b>LEVELEZE® KLEENATRON® II SPECIAL-DUTY</b>				<b>58460A</b> 	<b>FLOOR CLEANOUT</b>																																																																													
	<b>LIST PRICE</b>					<b>LIST PRICE</b>																																																																													
<table border="1"> <thead> <tr> <th>PIPE SIZE</th> <th>55000</th> <th>55000-1 55000-2</th> <th>55000-SS 55000-1-SQ</th> </tr> </thead> <tbody> <tr> <td>2"</td> <td>\$190.00</td> <td>\$270.00</td> <td>\$270.00</td> </tr> <tr> <td>3"</td> <td>226.00</td> <td>306.00</td> <td>306.00</td> </tr> <tr> <td>4"</td> <td>276.00</td> <td>356.00</td> <td>356.00</td> </tr> <tr> <td>5" (Z)</td> <td>463.00</td> <td>543.00</td> <td>543.00</td> </tr> <tr> <td>6" (Z)</td> <td>526.00</td> <td>606.00</td> <td>606.00</td> </tr> </tbody> </table>	PIPE SIZE	55000	55000-1 55000-2	55000-SS 55000-1-SQ	2"	\$190.00	\$270.00	\$270.00	3"	226.00	306.00	306.00	4"	276.00	356.00	356.00	5" (Z)	463.00	543.00	543.00	6" (Z)	526.00	606.00	606.00	<b>ADD FOR OPTIONS:</b>				<table border="1"> <thead> <tr> <th>PIPE SIZE</th> <th>2", 3"</th> <th>4"</th> </tr> </thead> <tbody> <tr> <td></td> <td>\$451.00</td> <td>\$468.00</td> </tr> </tbody> </table>	PIPE SIZE	2", 3"	4"		\$451.00	\$468.00																																																
PIPE SIZE	55000	55000-1 55000-2	55000-SS 55000-1-SQ																																																																																
2"	\$190.00	\$270.00	\$270.00																																																																																
3"	226.00	306.00	306.00																																																																																
4"	276.00	356.00	356.00																																																																																
5" (Z)	463.00	543.00	543.00																																																																																
6" (Z)	526.00	606.00	606.00																																																																																
PIPE SIZE	2", 3"	4"																																																																																	
	\$451.00	\$468.00																																																																																	
<table border="0"> <tr> <td>-1 .....</td> <td>\$80.00</td> <td>-14 .....</td> <td>\$36.00</td> </tr> <tr> <td>-1-SD .....</td> <td>134.00</td> <td>-VP .....</td> <td>43.00</td> </tr> <tr> <td>-1-12 .....</td> <td>80.00</td> <td>-22 (2"-4") .....</td> <td>86.00</td> </tr> <tr> <td>-1-13 .....</td> <td>242.00</td> <td>-22 (5", 6") .....</td> <td>282.00</td> </tr> <tr> <td>-1-SQ .....</td> <td>80.00</td> <td>-31 .....</td> <td>99.00</td> </tr> <tr> <td>-2 .....</td> <td>80.00</td> <td>-41 .....</td> <td>48.00</td> </tr> <tr> <td>-2-SD .....</td> <td>134.00</td> <td>-F .....</td> <td>0.00</td> </tr> <tr> <td>-2-12 .....</td> <td>80.00</td> <td>-WF* .....</td> <td>217.00</td> </tr> <tr> <td>-2-13 .....</td> <td>242.00</td> <td>-CFC .....</td> <td>131.00</td> </tr> <tr> <td>-2-SQ .....</td> <td>80.00</td> <td>-X .....</td> <td>0.00</td> </tr> <tr> <td>-SS .....</td> <td>80.00</td> <td>-Y .....</td> <td>0.00</td> </tr> <tr> <td>-SS-SQ .....</td> <td>80.00</td> <td>-Z .....</td> <td>0.00</td> </tr> <tr> <td>-5 .....</td> <td>139.00</td> <td></td> <td></td> </tr> </table> <p>* Not Available on Cast Iron</p>				-1 .....	\$80.00	-14 .....	\$36.00	-1-SD .....	134.00	-VP .....	43.00	-1-12 .....	80.00	-22 (2"-4") .....	86.00	-1-13 .....	242.00	-22 (5", 6") .....	282.00	-1-SQ .....	80.00	-31 .....	99.00	-2 .....	80.00	-41 .....	48.00	-2-SD .....	134.00	-F .....	0.00	-2-12 .....	80.00	-WF* .....	217.00	-2-13 .....	242.00	-CFC .....	131.00	-2-SQ .....	80.00	-X .....	0.00	-SS .....	80.00	-Y .....	0.00	-SS-SQ .....	80.00	-Z .....	0.00	-5 .....	139.00			<b>ADD FOR OPTIONS:</b>			<table border="0"> <tr> <td>-AE .....</td> <td>\$109.00</td> <td>-12 .....</td> <td>\$164.00</td> </tr> <tr> <td>-1 .....</td> <td>184.00</td> <td>-14 .....</td> <td>36.00</td> </tr> <tr> <td>-2 .....</td> <td>159.00</td> <td>-VP .....</td> <td>69.00</td> </tr> <tr> <td>-6 .....</td> <td>148.00</td> <td>-20 .....</td> <td>0.00</td> </tr> <tr> <td>-6-1 .....</td> <td>366.00</td> <td>-31 .....</td> <td>205.00</td> </tr> <tr> <td>-6-2 .....</td> <td>315.00</td> <td>-X .....</td> <td>0.00</td> </tr> </table>	-AE .....	\$109.00	-12 .....	\$164.00	-1 .....	184.00	-14 .....	36.00	-2 .....	159.00	-VP .....	69.00	-6 .....	148.00	-20 .....	0.00	-6-1 .....	366.00	-31 .....	205.00	-6-2 .....	315.00	-X .....	0.00
-1 .....	\$80.00	-14 .....	\$36.00																																																																																
-1-SD .....	134.00	-VP .....	43.00																																																																																
-1-12 .....	80.00	-22 (2"-4") .....	86.00																																																																																
-1-13 .....	242.00	-22 (5", 6") .....	282.00																																																																																
-1-SQ .....	80.00	-31 .....	99.00																																																																																
-2 .....	80.00	-41 .....	48.00																																																																																
-2-SD .....	134.00	-F .....	0.00																																																																																
-2-12 .....	80.00	-WF* .....	217.00																																																																																
-2-13 .....	242.00	-CFC .....	131.00																																																																																
-2-SQ .....	80.00	-X .....	0.00																																																																																
-SS .....	80.00	-Y .....	0.00																																																																																
-SS-SQ .....	80.00	-Z .....	0.00																																																																																
-5 .....	139.00																																																																																		
-AE .....	\$109.00	-12 .....	\$164.00																																																																																
-1 .....	184.00	-14 .....	36.00																																																																																
-2 .....	159.00	-VP .....	69.00																																																																																
-6 .....	148.00	-20 .....	0.00																																																																																
-6-1 .....	366.00	-31 .....	205.00																																																																																
-6-2 .....	315.00	-X .....	0.00																																																																																
<b>56670</b> 	<b>SPANNER TYPE FLOOR CLEANOUT</b>					<b>Cleanout OPTION DESCRIPTIONS</b>																																																																													
	<b>LIST PRICE</b>																																																																																		
<table border="1"> <thead> <tr> <th>PIPE SIZE</th> <th>2"</th> <th>3"</th> <th>4"</th> <th>5"</th> <th>6"</th> </tr> </thead> <tbody> <tr> <td></td> <td>\$226.00</td> <td>\$314.00</td> <td>\$348.00</td> <td>\$547.00</td> <td>\$599.00</td> </tr> </tbody> </table>	PIPE SIZE	2"	3"	4"	5"	6"		\$226.00	\$314.00	\$348.00	\$547.00	\$599.00	<b>ADD FOR OPTIONS:</b>					<p>-AE Adjustable Extension</p> <p>-CFC Carpet Cleanout Flange Cover</p> <p>-F Flange Only</p> <p>-LT Less Top</p> <p>-SS Stainless Steel Top</p> <p>-SS-SQ Square Top, Stainless Steel</p> <p>-VP Secured Cover, Vandal-Proof Screws</p> <p>-WF Wide Flange (not available on CI)</p> <p>-1 Satin Finish Nikaloy Top</p> <p>-1-SD Special Duty Satin Finish Nikaloy Top</p> <p>-1-SQ Square Top, Satin Finish Nikaloy</p> <p>-1-12 Cover Recessed for Tile, Satin Finish Nikaloy</p> <p>-1-13 Terrazzo Tile Cover, Satin Finish Nikaloy</p> <p>-2 Satin Finish Bronze Top</p> <p>-2-SD Special Duty Satin Finish Bronze Top</p> <p>-2-SQ Square Top, Satin Finish Bronze</p> <p>-2-12 Cover Recessed for Tile, Satin Finish Bronze</p> <p>-2-13 Terrazzo Tile Cover, Satin Finish Bronze</p> <p>-5 Ductile Iron Top</p> <p>-6 Square Top, Cast Iron</p> <p>-6-1 Square Top, Nikaloy</p> <p>-6-2 Square Top, Bronze</p> <p>-11 Smooth Top</p> <p>-12 Cover Recessed for Tile</p> <p>-14 Carpet Cleanout Marker</p> <p>-20 Raised Head Bronze Plug</p> <p>-22 Taper Thread Bronze Plug</p> <p>-24 Spanner Wrench</p> <p>-31 Galvanized Cast Iron Parts</p> <p>-41 Clamp Ring and Flange</p> <p><b>Outlets</b></p> <p>-X Inside Caulk Outlet</p> <p>-Y Hub Outlet w/Gasket 2" -4"</p> <p>-Z No-Hub Outlet</p>																																																																	
PIPE SIZE	2"	3"	4"	5"	6"																																																																														
	\$226.00	\$314.00	\$348.00	\$547.00	\$599.00																																																																														
<table border="0"> <tr> <td>-2 .....</td> <td>Deduct \$35.00</td> <td>-24 .....</td> <td>\$69.00</td> </tr> <tr> <td>-11 .....</td> <td>0.00</td> <td>-X .....</td> <td>0.00</td> </tr> <tr> <td>-14 .....</td> <td>36.00</td> <td></td> <td></td> </tr> </table>					-2 .....	Deduct \$35.00	-24 .....	\$69.00	-11 .....	0.00	-X .....	0.00	-14 .....	36.00																																																																					
-2 .....	Deduct \$35.00	-24 .....	\$69.00																																																																																
-11 .....	0.00	-X .....	0.00																																																																																
-14 .....	36.00																																																																																		
<b>57008-Z-CI</b> 	<b>LEVELEZE® KLEENATRON® SPECIAL-DUTY CAST IRON TOP 57008-Z-CI Standard</b>				<b>Cleanout OPTION DESCRIPTIONS</b>																																																																														
	<b>LIST PRICE</b>																																																																																		
<table border="1"> <thead> <tr> <th>PIPE SIZE</th> <th>8"</th> <th>\$650.00</th> </tr> </thead> <tbody> <tr> <td></td> <td></td> <td></td> </tr> </tbody> </table>	PIPE SIZE	8"	\$650.00				<b>ADD FOR OPTIONS:</b>				<p>-1 .....</p>	\$106.00	-2-12 .....	\$79.00																																																																					
PIPE SIZE	8"	\$650.00																																																																																	
-1-SD .....	179.00	-14 .....	36.00																																																																																
-1-SQ .....	106.00	-VP .....	43.00																																																																																
-1-12 .....	108.00	-LT .....	Deduct 289.00																																																																																
-2 .....	79.00	-31 .....	99.00																																																																																
-2-SD .....	152.00	-CFC .....	131.00																																																																																
-2-SQ .....	79.00	-Z .....	STD																																																																																

			**58360**	**ADJUSTABLE FLOOR CLEANOUT**					**Cleanout OPTION DESCRIPTIONS**																					
**LIST PRICE**																														
	PIPE SIZE	2"	3"	4"	5"	6"		-----------	----------	----------	----------	----------	----------			\$228.00	\$261.00	\$299.00	\$337.00	\$344.00		**ADD FOR OPTIONS:**					-2 .....	Deduct \$17.00	-31 .....	\$41.00
-14 .....	36.00	-Y .....	0.00																											
-VP .....	43.00	-Z .....	0.00																											



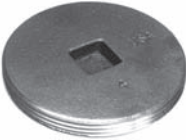

	<b>58540</b>							
	<b>THREADED BRONZE PLUG</b>							
	<b>LIST PRICE</b>							
	<b>PIPE SIZE</b>	<b>1"</b>	<b>1-1/4"</b>	<b>1-1/2"</b>	<b>2"</b>	<b>2-1/2"</b>	<b>3"</b>	
	\$19.00	\$19.00	\$19.00	\$25.00	\$31.00	\$43.00		
<b>PIPE SIZE</b>	<b>3-1/2"</b>	<b>4"</b>	<b>5"</b>	<b>6"</b>	<b>8"</b>	<b>*10"</b>		
	\$71.00	\$80.00	\$119.00	\$164.00	\$330.00	\$487.00		
<b>ADD FOR OPTIONS:</b>								
-19 .....	\$21.00						-20 .....	\$0.00
* For 10" Size, Specify 58549-20. 10" Size Available with Raised Head Plug Only								

	<b>58620</b>		
	<b>WALL OR FLOOR ACCESS COVER</b>		
	<b>LIST PRICE</b>		
	<b>TYPE NO.</b>	<b>58624</b>	<b>58626</b>
	\$376.00	\$489.00	
<b>ADD FOR OPTIONS:</b>			
-2 (58624) .....	Deduct \$26.00	-C06.....	\$193.00
-2 (58626) .....	Deduct 53.00	-20* .....	0.00
-10 .....	0.00	-31* .....	72.00
-14 .....	36.00	-COT2 .....	104.00
-VP .....	43.00	-COT3 .....	130.00
-C02 .....	43.00	-COT4 .....	204.00
-C03 .....	69.00	-COT6 .....	578.00
-C04 .....	94.00		
* Specify -CO or -COT.			

	<b>58580</b>				
	<b>ACCESS HOUSING AND COVER</b>				
	<b>LIST PRICE</b>				
	<b>PIPE SIZE</b>	<b>58580</b>	<b>58580-1</b>	<b>58580-2</b>	<b>58580-5</b>
		<b>58580-SQ</b>			
2"	\$139.00	\$191.00	\$174.00	\$278.00	
3", 4"	194.00	270.00	246.00	333.00	
5", 6"	256.00	341.00	323.00	395.00	
<b>ADD FOR OPTIONS:</b>					
-1 (2") .....	\$52.00	-5 .....	\$139.00		
-1 (3", 4") .....	76.00	-SD .....	72.00		
-1 (5", 6") .....	85.00	-SQ (2") .....	52.00		
-2 (2") .....	35.00	-SQ (3", 4") .....	76.00		
-2 (3", 4") .....	52.00	-SQ (5", 6") .....	85.00		
-2 (5", 6") .....	67.00				



	<b>58630</b>		
	<b>WALL OR FLOOR ACCESS COVER</b>		
	<b>LIST PRICE</b>		
	<b>TYPE NO.</b>	<b>58631</b>	<b>58632</b>
	\$365.00	\$538.00	
<b>ADD FOR OPTIONS:</b>			
-2 (58631) .....	Deduct \$35.00	-20* .....	\$0.00
-2 (58632) .....	Deduct 58.00	-31* .....	72.00
-VP .....	43.00	-COT2 .....	104.00
-C02 .....	43.00	-COT3 .....	130.00
-C03 .....	69.00	-COT4 .....	204.00
-C04 .....	94.00	-COT6 .....	578.00
-C06 .....	193.00		
* Specify -CO or -COT.			

	<b>58600</b>			
	<b>WALL ACCESS COVER</b>			
	<b>LIST PRICE</b>			
	<b>TYPE NO.</b>	<b>58604</b>	<b>58606</b>	<b>58608</b>
	\$64.00	\$80.00	\$218.00	
<b>ADD FOR OPTIONS:</b>				
-VP .....	\$32.00	-20* .....	\$0.00	
-17 .....	8.00	-C02 .....	43.00	
-PLG1-1/2 .....	19.00	-C03 .....	69.00	
-PLG2 .....	25.00	-C04 .....	94.00	
-PLG2-1/2 .....	31.00	-C06 .....	193.00	
-PLG3 .....	43.00	-31** .....	72.00	
-PLG3-1/2 .....	71.00	-COT2 .....	104.00	
-PLG4 .....	80.00	-COT3 .....	130.00	
-PLG5 .....	119.00	-COT4 .....	204.00	
-PLG6 .....	164.00	-COT6 .....	578.00	
* Specify -PLG, -CO or -COT. ** Specify -CO or -COT.				

	<b>58640</b>			
	<b>WALL ACCESS COVER</b>			
	<b>LIST PRICE</b>			
	<b>TYPE NO.</b>	<b>58642</b>	<b>58644</b>	<b>58646</b>
	\$277.00	\$407.00	\$439.00	
<b>ADD FOR OPTIONS:</b>				
-2 (58642) .....	Deduct \$37.00	-C06.....	\$193.00	
-2 (58644) .....	Deduct 53.00	-20* .....	0.00	
-2 (58646) .....	Deduct 58.00	-31* .....	72.00	
-10 .....	0.00	-COT2 .....	104.00	
-VP .....	43.00	-COT3 .....	130.00	
-C02 .....	43.00	-COT4 .....	204.00	
-C03 .....	69.00	-COT6 .....	578.00	
-C04 .....	94.00			
* Specify -CO or -COT.				

	<b>58610</b>		
	<b>WALL OR FLOOR ACCESS COVER</b>		
	<b>LIST PRICE</b>		
	<b>TYPE NO.</b>	<b>58614</b>	<b>58616</b>
	\$164.00	\$281.00	\$405.00
<b>ADD FOR OPTIONS:</b>			
-2 (58614) .....	Deduct \$16.00	-C04.....	\$94.00
-2 (58616) .....	Deduct 50.00	-C06.....	193.00
-2 (58618) .....	Deduct 50.00	-20* .....	0.00
-10 .....	0.00	-31* .....	72.00
-14 .....	36.00	-COT2 .....	104.00
-VP .....	43.00	-COT3 .....	130.00
-C02 .....	43.00	-COT4 .....	204.00
-C03 .....	69.00	-COT6 .....	578.00
* Specify -CO or -COT.			

	<b>58650</b>		
	<b>STAINLESS STEEL WALL ACCESS COVER</b>		
	<b>LIST PRICE</b>		
	<b>TYPE NO.</b>	<b>58656</b>	<b>\$407.00</b>
<b>ADD FOR OPTIONS:</b>			
-VP .....	\$43.00	-31* .....	\$72.00
-C02 .....	43.00	-COT2 .....	104.00
-C03 .....	69.00	-COT3 .....	130.00
-C04 .....	94.00	-COT4 .....	204.00
-C06 .....	193.00	-COT6 .....	578.00
-20* .....	0.00		
* Specify -CO or -COT.			

<b>58680</b> 	<b>ACCESS COVER</b>				
	<b>LIST PRICE</b>				
	TYPE NO.	58680		\$640.00	
	<b>ADD FOR OPTIONS:</b>				
	-5 .....	\$212.00	-CO3.....	\$69.00	
	-VP .....	43.00	-CO4.....	94.00	
	-26 .....	77.00	-CO6.....	193.00	
	-31 .....	256.00	-20* .....	0.00	
	-CO2.....	43.00			
	Special Wording on Cover, SAN. or STORM, Specify on Order.				
	* Specify -CO				
<b>58900</b> 	<b>NO-HUB CLEANOUT FERRULE</b>				
	<b>LIST PRICE</b>				
	PIPE SIZE	2"	3"	4"	6"
		\$43.00	\$69.00	\$94.00	\$193.00
	<b>ADD FOR OPTIONS:</b>				
	-19 .....	\$21.00	-31 .....	\$72.00	
	-20 .....	0.00	-Z .....	0.00	
<b>58910</b> 	<b>NO-HUB CLEANOUT TEE WITH PLUG</b>				
	<b>LIST PRICE</b>				
	PIPE SIZE	2"	3"	4"	6"
		\$104.00	\$130.00	\$204.00	\$578.00
	<b>ADD FOR OPTIONS:</b>				
	-19 .....	\$21.00	-31 .....	\$72.00	
	-20 .....	0.00	-Z .....	0.00	

### OPTION DESCRIPTIONS





- CO2 No-Hub Cleanout, 2"
- CO3 No-Hub Cleanout, 3"
- CO4 No-Hub Cleanout, 4"
- CO6 No-Hub Cleanout, 6"
- COT2 No-Hub Cleanout Tee, 2"
- COT3 No-Hub Cleanout Tee, 3"
- COT4 No-Hub Cleanout Tee, 4"
- COT6 No-Hub Cleanout Tee, 6"
- PLG1-1/2 Bronze NPT Plug, 1-1/2"
- PLG2 Bronze NPT Plug, 2"
- PLG2-1/2 Bronze NPT Plug, 2-1/2"
- PLG3 Bronze NPT Plug, 3"
- PLG3-1/2 Bronze NPT Plug, 3-1/2"
- PLG4 Bronze NPT Plug, 4"
- PLG5 Bronze NPT Plug, 5"
- PLG6 Bronze NPT Plug, 6"
- SD Special-Duty Top, Nikaloy
- SQ Square Top
- VP Secured Cover, Vandal-Proof Screws
- 1 Satin Finish Nikaloy Top
- 2 Satin Finish Bronze Top
- 5 Ductile Iron Top
- 10 Scoriated Cover
- 14 Carpet Cleanout Marker
- 17 Center Screw Longer than Standard
- 19 Plug Tapped for Center Screw
- 20 Raised Head Bronze Plug
- 26 Gasketed Cover
- 31 Galvanized Cast Iron Parts

### Outlet

- Z No-Hub Outlet

# GREASE INTERCEPTORS



	<b>MANUAL CLEANING, ON-FLOOR TYPE</b>													
	TYPE NO.	PIPE SIZE	FLOW RATE GPM	GR. CAP. LBS.	LIST PRICE	FOR OPTIONS, ADD TO LIST PRICE								
						-40	-61	-ISI	-EXT 6"	Ea. Add'l Inch Ext.	-RT	-ET	-HD	
	60102H	2	7	14	\$1,491.00	N/A	N/A	\$844.00	N/A	N/A	\$3,139.00	\$3,620.00	\$2,630.00	
	60103H	2	10	20	1,752.00	\$2,424.00	\$813.00	844.00	\$2,173.00	\$108.00	3,265.00	3,792.00	2,828.00	
	60104H	2	15	30	2,594.00	2,941.00	813.00	844.00	2,203.00	121.00	3,502.00	4,131.00	3,041.00	
	60105H	3	20	40	3,175.00	3,289.00	813.00	844.00	2,203.00	138.00	3,727.00	4,453.00	3,221.00	
	60106H	3	25	50	3,567.00	3,802.00	908.00	866.00	2,203.00	155.00	3,806.00	4,604.00	3,399.00	
	60107H	3	35	70	4,409.00	4,666.00	943.00	980.00	2,669.00	171.00	3,806.00	5,018.00	3,756.00	
	60108H	3	50	100	5,839.00	6,487.00	1,071.00	1,465.00	2,887.00	200.00	4,218.00	5,285.00	3,936.00	
60109H	4	75	150	12,000.00	POA	1,700.00	1,580.00	3,000.00	220.00	N/A	N/A	4,200.00		
60110H	4	100	200	13,500.00	POA	1,900.00	1,730.00	3,400.00	250.00	N/A	N/A	5,600.00		
<b>ADD FOR OPTIONS</b>														
-40 .....			ABOVE			-RT .....			ABOVE			-SAP .....		POA•
-61 .....			ABOVE			-ET .....			ABOVE			-GRD* .....		POA•
-ISI* .....			ABOVE			-HD .....			ABOVE			-GRDP .....		POA•
-EXT .....			ABOVE			-SS .....			POA•					
<p>* -GRD Available Only on 60104H through 60110H.                      -GRD and -ISI Cannot be Furnished Together.</p> <p>• PRICE ON APPLICATION</p>														
	<b>SEMI-AUTOMATIC</b>													
	TYPE NO.	PIPE SIZE	FLOW RATE GPM	GREASE CAP. LBS.	LIST PRICE	FOR OPTIONS, ADD TO LIST PRICE								
						-RT	-ET							
	60102-SA	2	7	14	\$4,247.00	\$3,407.00	\$4,173.00							
	60103-SA	2	10	20	5,010.00	3,957.00	4,741.00							
	60104-SA	2	15	30	5,338.00	4,396.00	5,273.00							
	60105-SA	2	20	40	6,561.00	4,468.00	5,457.00							
	60106-SA	3*	25	50	7,958.00	4,552.00	5,671.00							
	60107-SA	3*	35	70	8,167.00	4,865.00	6,083.00							
	60108-SA	3*	50	100	9,322.00	4,910.00	6,290.00							
<b>ADD FOR OPTIONS</b>														
-62 .....			\$0.00			-66 .....			147.00			-RT .....		ABOVE
-65 .....			105.00			-67 .....			207.00			-ET .....		ABOVE
* 3" Sizes Normally Furnished with 4" x 3" Reducing Bushings.														
	<b>MANUAL CLEANING, LOW TYPE</b>						<b>SEMI-AUTOMATIC, LOW TYPE</b>							
	TYPE NO.	PIPE SIZE	FLOW RATE GPM	GREASE CAP. LBS.	LIST PRICE		TYPE NO.	PIPE SIZE	FLOW RATE GPM	GREASE CAP. LBS.	LIST PRICE			
	60115A	2*	20	40	\$4,759.00		60115A-SA	3	35	70	\$11,159.00			
	60117A	3	35	70	6,128.00									
	<b>ADD FOR OPTIONS:</b>													
	-65 .....			\$105.00			-68 .....			\$0.00				
-66 .....			147.00											
*2" Sizes Normally Furnished with 3" x 2" Reducing Bushings														

	<b>MANUAL CLEANING TYPE, HIGH VOLUME</b>											
	TYPE NO.	PIPE SIZE	FLOW RATE GPM	GREASE CAP. LBS.	LIST PRICE	FOR OPTIONS, ADD TO LIST PRICE						
						-EXT 6"	Ea. Add'l Inch Ext.	-60	-61	-ISI	-HD	
	60213A	4	150	300	\$16,339.00	\$1,941.00	\$150.00	\$1,490.00	\$2,400.00	\$1,846.00	\$7,342.00	
	60214A	5	200	400	23,703.00	3,493.00	157.00	1,597.00	2,804.00	1,940.00	8,373.00	
	60215A	5	250	500	27,592.00	4,340.00	170.00	2,130.00	3,782.00	2,047.00	11,560.00	
	60216A	6	350	700	36,128.00	6,028.00	217.00	2,694.00	4,525.00	2,585.00	17,497.00	
	60217A	6	500	1000	47,107.00	9,059.00	258.00	3,199.00	5,379.00	3,063.00	24,620.00	
	<b>ADD FOR OPTIONS</b>											
	-EXT ..... ABOVE    -61 ..... ABOVE    -HD ..... ABOVE -60 ..... ABOVE    -ISI ..... ABOVE    -SAP ..... POA• • PRICE ON APPLICATION											

	<b>GI 2000A AUTOMATIC GREASE REMOVAL DEVICE</b>					<b>OPTION DESCRIPTIONS</b>  -ET            Enclosed Type -EXT          Extension, 6" Standard, Specify Extension Height -GRD          Grease Removal Device -GRDP        Grease Removal Device with Probe -HD            Heavy-Duty Cover -ISI            Integrated Solids Interceptor -RT            Recessed Type -SAP          Sensing and Alarm Probe -SS            Stainless Steel -23            Remote Monitoring Package (-23A) Monitoring Plan (-23B) Monitoring Plan (-23C) Monitoring Plan -40            Cover Recess for Floor Finish -61            Flange and Clamp Device -62            4" Inlet and Outlet Available on Standard 3" Sizes -65            Hub Inlet, Spigot Outlet, 2" -66            Hub Inlet, Spigot Outlet, 3" -67            Hub Inlet, Spigot Outlet, 4" -68            3" Inlet and Outlet Available on Standard 2" Size
	TYPE NO.	PIPE SIZE	FLOW RATE GPM	GREASE CAP. LBS.	LIST PRICE	
	60306A	3	25	50	POA•	
	60307A	3	35	70	POA•	
	60308A	3	50	100	POA•	
	60309A	4	75	150	POA•	
	60310A	4	100	200	POA•	
	60311A	4	150	300	POA•	
	60312A	6	200	400	POA•	
	60313A	6	250	500	POA•	
60314A	6	350	700	POA•		
60315A	6	500	1000	POA•		
<b>ADD FOR OPTIONS:</b>						
-23 ..... JSP◇    -24 ..... POA• -23A ..... JSP◇    -33 ..... POA• -23B ..... JSP◇    -34 ..... POA• -23C ..... JSP◇ • PRICE ON APPLICATION            ◇ Josam Service Program						









  









	<b>ELECTRONIC GREASE/OIL LEVEL DETECTOR</b>		
	<b>LIST PRICE</b>		
	TYPE NO.	EGOLD-1000	POA•
	<b>ADD FOR OPTIONS:</b>		
-23 ..... JSP◇    -23B ..... JSP◇ -23A ..... JSP◇    -23C ..... JSP◇ • PRICE ON APPLICATION            ◇ Josam Service Program			



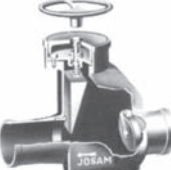





  

	<b>PIT ELECTRONIC GREASE/OIL LEVEL DETECTOR</b>		
	<b>LIST PRICE</b>		
	TYPE NO.	CEGOLD-2000	POA•
	<b>ADD FOR OPTIONS:</b>		
-23 ..... JSP◇    -23B ..... JSP◇ -23A ..... JSP◇    -23C ..... JSP◇ • PRICE ON APPLICATION            ◇ Josam Service Program			



60500B		DRAW-OFF, GRAVITY TYPE									
		TYPE NO.	PIPE SIZE	FLOW RATE GPM	LIST PRICE	FOR OPTIONS, ADD TO LIST PRICE					
						-EXT 6"	Ea. Add'l Inch Ext.	-60	-61	-HD	
		60503B	2	10	\$2,657.00	\$2,487.00	\$109.00	\$678.00	\$815.00	\$2,828.00	
		60504B	2	15	2,649.00	2,520.00	122.00	678.00	815.00	3,041.00	
		60505B	3*	20	4,413.00	2,594.00	136.00	732.00	815.00	3,221.00	
		60506B	3*	25	4,789.00	2,669.00	157.00	762.00	908.00	3,399.00	
		60507B	3*	35	5,822.00	2,769.00	170.00	800.00	944.00	3,756.00	
		60508B	3*	50	7,833.00	3,306.00	197.00	816.00	1,075.00	3,936.00	
* 3" Sizes Normally Furnished with 4" x 3" Reducing Bushings.											
ADD FOR OPTIONS											
-EXT ..... ABOVE    -61 ..... ABOVE    -HD..... ABOVE											
-60 ..... ABOVE											
60500-EST		DRAW-OFF, GRAVITY TYPE WITH EXTERNAL STORAGE TANK									
		TYPE NO.	PIPE SIZE	FLOW RATE GPM	TANK CAP. GAL.	LIST PRICE	FOR OPTIONS, ADD TO LIST PRICE				
							-EXT 6"	Ea. Add'l Inch Ext.	-60	-61	-HD
		60503-EST	2	10	5	\$3,989.00	\$3,730.00	\$154.00	\$1,010.00	\$1,220.00	\$4,500.00
		60504-EST	2	15	6	5,470.00	3,780.00	185.00	1,010.00	1,220.00	4,790.00
		60505-EST	3*	20	8	6,620.00	3,895.00	210.00	1,010.00	1,220.00	5,070.00
		60506-EST	3*	25	50	7,180.00	3,930.00	230.00	1,145.00	1,335.00	5,255.00
		60506-EST	3*	25	100	7,990.00	4,125.00	235.00	1,145.00	1,335.00	5,780.00
		60507-EST	3*	35	50	8,730.00	4,070.00	250.00	1,170.00	1,380.00	5,530.00
		60507-EST	3*	35	100	9,540.00	4,275.00	255.00	1,170.00	1,380.00	6,080.00
		60508-EST	3*	50	100	11,540.00	4,850.00	290.00	1,190.00	1,580.00	5,810.00
* 3" Sizes Normally Furnished with 4" x 3" Reducing Bushings.											
ADD FOR OPTIONS											
-EXT ..... ABOVE    -61 ..... ABOVE    -HD..... ABOVE											
-60 ..... ABOVE											
60610A		DRAW-OFF TYPE, HIGH VOLUME									
		TYPE NO.	PIPE SIZE	FLOW RATE GPM	LIST PRICE	FOR OPTIONS, ADD TO LIST PRICE					
						-EXT 6"	Ea. Add'l Inch Ext.	-60	-61	-HD	
		60611A	3	75	13,570.00	1,863.00	122.00	808.00	1,612.00	\$4,156.00	
		60612A	4	100	14,716.00	1,941.00	130.00	995.00	1,804.00	5,715.00	
		60613A	4	150	18,221.00	2,098.00	150.00	1,388.00	2,236.00	7,342.00	
		60614A	5	200	25,743.00	2,999.00	157.00	1,488.00	2,612.00	8,373.00	
		60615A	5	250	29,813.00	3,900.00	170.00	1,989.00	3,387.00	11,560.00	
		60616A	6	350	37,679.00	5,616.00	217.00	2,507.00	4,210.00	17,497.00	
		60617A	6	500	54,740.00	8,746.00	258.00	2,976.00	5,010.00	24,620.00	
ADD FOR OPTIONS											
-EXT ..... ABOVE    -61 ..... ABOVE    -HD..... ABOVE											
-60 ..... ABOVE											





 <p><b>NEW</b> EXTERNAL STORAGE TANK NOT SHOWN</p>	<b>DRAW-OFF, GRAVITY TYPE WITH EXTERNAL STORAGE TANK</b>									
	TYPE NO.	PIPE SIZE	FLOW RATE GPM	TANK CAP. GAL	LIST PRICE	FOR OPTIONS, ADD TO LIST PRICE				
						-EXT 10"	Ea. Add'l Inch Ext.	-60	-61	-HD
	60611-EST	3	75	100	\$19,990.00	\$2,740.00	\$185.00	\$1,315.00	\$2,380.00	\$6,110.00
	60612-EST	4	100	250	22,080.00	2,910.00	197.00	1,505.00	2,700.00	8,580.00
	60613-EST	4	150	250	27,330.00	3,140.00	225.00	2,080.00	3,350.00	11,010.00
	60614-EST	5	200	250	36,190.00	4,225.00	225.00	2,225.00	3,915.00	11,790.00
	60615-EST	5	250	500	41,920.00	5,480.00	245.00	2,790.00	4,750.00	16,200.00
	60616-EST	6	350	500	52,990.00	7,900.00	305.00	3,520.00	5,910.00	23,420.00
	60617-EST	6	500	500	73,100.00	11,750.00	360.00	4,190.00	7,040.00	34,600.00
<b>ADD FOR OPTIONS</b>										
-EXT ..... ABOVE    -61 ..... ABOVE    -HD ..... ABOVE -60 ..... ABOVE										
	<b>OIL SEDIMENT INTERCEPTOR</b>					<b>TOP ACCESS ON-FLOOR TRAP TYPE</b>				
	TYPE NO.	PIPE SIZE	LIST PRICE			TYPE NO.	PIPE SIZE	LIST PRICE		
	60816	2	\$1,748.00			61042A	2	\$2,360.00		
	60817	4	4,716.00			61043A	3	2,360.00		
	60818	4	6,705.00			61044A	4	2,360.00		
60819	4	9,936.00		<b>ADD FOR OPTIONS:</b> -16 ..... \$379.00    -EXT* ..... \$401.00 * 6" Standard, Each Add'l. Inch ..... \$44.00						
	<b>BOTTOM ACCESS FIXTURE TRAP TYPE</b>					<b>TOP ACCESS IN-LINE TYPE</b>				
	TYPE NO.	INLET	OUTLET	LIST PRICE		TYPE NO.	PIPE SIZE	LIST PRICE		
	61001-1/4	1-1/4	1-1/2	\$821.00		61072	2	\$1,472.00		
	61001-1/2	1-1/2	1-1/2	821.00		61073	3	2,436.00		
	<b>ADD FOR OPTIONS:</b> -1 ..... Deduct \$372.00    -30 ..... Deduct \$136.00 -3 ..... 0.00					61074	4	3,397.00		
<b>ADD FOR OPTIONS:</b> -4 ..... \$582.00    -86 ..... \$0.00 -15 ..... 722.00										
	<b>TOP ACCESS FIXTURE TRAP TYPE</b>					<b>TOP ACCESS IN-LINE TYPE</b>				
	TYPE NO.	PIPE SIZE	LIST PRICE			TYPE NO.	PIPE SIZE	LIST PRICE		
	61031-1/2	1-1/2	\$610.00			61084	4	\$5,762.00		
	61032	2	610.00			61085	5	5,762.00		
	<b>ADD FOR OPTIONS:</b> -26 ..... \$338.00    -30 ..... \$174.00					61086	6	5,762.00		
<b>ADD FOR OPTIONS:</b> -4 ..... \$1,288.00    -86 ..... \$0.00 -15 ..... 943.00										
	<b>LINT INTERCEPTOR</b>									
	TYPE NO.	PIPE SIZE	FLOW RATE GPM	MAX. NUMBER OF WASHERS	LIST PRICE	FOR OPTIONS, ADD TO LIST PRICE				
						-EXT 6"	Ea. Add'l Inch Ext.			
	61805	3	70	7	\$6,107.00	\$2,203.00	\$138.00			
	61806	4	200	20	8,696.00	2,203.00	155.00			
	61807	6	300	30	10,110.00	2,669.00	171.00			
61808	6	400	40	11,528.00	2,887.00	200.00				
<b>OPTION DESCRIPTIONS</b>										
-EXT	Extension, 6" Standard, Specify Extension Height				-16	Monel Screens				
-HD	Heavy-Duty Cover				-26	Cast Aluminum				
-1	Painted Cast Iron				-30	Acid-Resisting Cast Iron Inside and Outside				
-3	Polished Bronze				-60	Anchor Flange				
-4	Galvanized Cast Iron Parts				-61	Flange and Clamp Device				
-15	Stainless Steel Basket				-86	Flat Bottom Basket				

<p><b>67100A</b></p> 	<p><b>BALL-FLOAT ADAPTER TYPE</b></p> <table border="1"> <thead> <tr> <th colspan="3">LIST PRICE</th> </tr> <tr> <th>PIPE SIZE</th> <th>2", 3", 4"</th> <th>6"</th> </tr> </thead> <tbody> <tr> <td></td> <td>\$267.00</td> <td>\$552.00</td> </tr> </tbody> </table> <p><b>ADD FOR OPTIONS:</b></p> <table> <tr> <td>-5 (2" - 4").....</td> <td>\$43.00</td> <td>-35 .....</td> <td>\$71.00</td> </tr> <tr> <td>-5 (6").....</td> <td>109.00</td> <td></td> <td></td> </tr> </table>	LIST PRICE			PIPE SIZE	2", 3", 4"	6"		\$267.00	\$552.00	-5 (2" - 4").....	\$43.00	-35 .....	\$71.00	-5 (6").....	109.00			<p><b>67650</b></p> 	<p><b>COMBINED DRAIN/SWING-CHECK TYPE</b></p> <table border="1"> <thead> <tr> <th colspan="3">LIST PRICE</th> </tr> <tr> <th>PIPE SIZE</th> <th>3", 4"</th> <th>6"</th> </tr> </thead> <tbody> <tr> <td></td> <td>\$842.00</td> <td>\$1,268.00</td> </tr> </tbody> </table> <p><b>ADD FOR OPTIONS:</b></p> <table> <tr> <td>-1 (3", 4") .....</td> <td>\$399.00</td> <td>-25 .....</td> <td>\$121.00</td> </tr> <tr> <td>-1 (6") .....</td> <td>347.00</td> <td>-VP .....</td> <td>66.00</td> </tr> <tr> <td>-2 (3", 4") .....</td> <td>267.00</td> <td>-LBV (3", 4")... Deduct</td> <td>178.00</td> </tr> <tr> <td>-2 (6") .....</td> <td>221.00</td> <td>-LBV (6") .....</td> <td>Deduct 312.00</td> </tr> <tr> <td>-5 .....</td> <td>267.00</td> <td></td> <td></td> </tr> </table>	LIST PRICE			PIPE SIZE	3", 4"	6"		\$842.00	\$1,268.00	-1 (3", 4") .....	\$399.00	-25 .....	\$121.00	-1 (6") .....	347.00	-VP .....	66.00	-2 (3", 4") .....	267.00	-LBV (3", 4")... Deduct	178.00	-2 (6") .....	221.00	-LBV (6") .....	Deduct 312.00	-5 .....	267.00		
LIST PRICE																																																	
PIPE SIZE	2", 3", 4"	6"																																															
	\$267.00	\$552.00																																															
-5 (2" - 4").....	\$43.00	-35 .....	\$71.00																																														
-5 (6").....	109.00																																																
LIST PRICE																																																	
PIPE SIZE	3", 4"	6"																																															
	\$842.00	\$1,268.00																																															
-1 (3", 4") .....	\$399.00	-25 .....	\$121.00																																														
-1 (6") .....	347.00	-VP .....	66.00																																														
-2 (3", 4") .....	267.00	-LBV (3", 4")... Deduct	178.00																																														
-2 (6") .....	221.00	-LBV (6") .....	Deduct 312.00																																														
-5 .....	267.00																																																
<p><b>67360</b></p> 	<p><b>SHEAR-GATE &amp; SWING-CHECK TYPE</b></p> <table border="1"> <thead> <tr> <th colspan="3">LIST PRICE</th> </tr> <tr> <th>PIPE SIZE</th> <th>67360</th> <th>67360-DH</th> </tr> </thead> <tbody> <tr> <td>3", 4"</td> <td>\$2,313.00</td> <td>\$2,313.00</td> </tr> <tr> <td>5", 6"</td> <td>3,406.00</td> <td>3,406.00</td> </tr> </tbody> </table> <p><b>ADD FOR OPTIONS:</b></p> <table> <tr> <td>-DH.....</td> <td>\$0.00</td> <td>-28 (5", 6") .....</td> <td>\$1,093.00</td> </tr> <tr> <td>-15 .....</td> <td>0.00</td> <td>-29 (3", 4") .....</td> <td>1,334.00</td> </tr> <tr> <td>-28 (3", 4") .....</td> <td>953.00</td> <td>-29 (5", 6") .....</td> <td>1,460.00</td> </tr> </table>	LIST PRICE			PIPE SIZE	67360	67360-DH	3", 4"	\$2,313.00	\$2,313.00	5", 6"	3,406.00	3,406.00	-DH.....	\$0.00	-28 (5", 6") .....	\$1,093.00	-15 .....	0.00	-29 (3", 4") .....	1,334.00	-28 (3", 4") .....	953.00	-29 (5", 6") .....	1,460.00	<p><b>67720</b></p> 	<p><b>HUB INLET, SWING-CHECK TYPE</b></p> <table border="1"> <thead> <tr> <th colspan="3">LIST PRICE</th> </tr> <tr> <th>PIPE SIZE</th> <th>3"</th> <th>4"</th> </tr> </thead> <tbody> <tr> <td></td> <td>\$250.00</td> <td>\$363.00</td> </tr> </tbody> </table> <p><b>ADD FOR OPTIONS:</b></p> <table> <tr> <td>-15 .....</td> <td>\$0.00</td> <td></td> <td></td> </tr> </table>	LIST PRICE			PIPE SIZE	3"	4"		\$250.00	\$363.00	-15 .....	\$0.00											
LIST PRICE																																																	
PIPE SIZE	67360	67360-DH																																															
3", 4"	\$2,313.00	\$2,313.00																																															
5", 6"	3,406.00	3,406.00																																															
-DH.....	\$0.00	-28 (5", 6") .....	\$1,093.00																																														
-15 .....	0.00	-29 (3", 4") .....	1,334.00																																														
-28 (3", 4") .....	953.00	-29 (5", 6") .....	1,460.00																																														
LIST PRICE																																																	
PIPE SIZE	3"	4"																																															
	\$250.00	\$363.00																																															
-15 .....	\$0.00																																																
<p><b>67400</b></p> 	<p><b>NO-HUB SWING-CHECK TYPE</b></p> <table border="1"> <thead> <tr> <th colspan="5">LIST PRICE</th> </tr> <tr> <th>PIPE SIZE</th> <th>2"</th> <th>3"</th> <th>4"</th> <th>6"</th> </tr> </thead> <tbody> <tr> <td></td> <td>\$599.00</td> <td>\$937.00</td> <td>\$1,154.00</td> <td>\$1,476.00</td> </tr> </tbody> </table>	LIST PRICE					PIPE SIZE	2"	3"	4"	6"		\$599.00	\$937.00	\$1,154.00	\$1,476.00	<p><b>67800</b></p> 	<p><b>HUB INLET, SWING-CHECK TYPE</b></p> <table border="1"> <thead> <tr> <th colspan="3">LIST PRICE</th> </tr> <tr> <th>PIPE SIZE</th> <th>6"</th> <th>8"</th> </tr> </thead> <tbody> <tr> <td></td> <td>\$1,037.00</td> <td>\$1,262.00</td> </tr> </tbody> </table> <p><b>ADD FOR OPTIONS:</b></p> <table> <tr> <td>-4 .....</td> <td>\$366.00</td> <td>-15 .....</td> <td>\$0.00</td> </tr> </table>	LIST PRICE			PIPE SIZE	6"	8"		\$1,037.00	\$1,262.00	-4 .....	\$366.00	-15 .....	\$0.00																		
LIST PRICE																																																	
PIPE SIZE	2"	3"	4"	6"																																													
	\$599.00	\$937.00	\$1,154.00	\$1,476.00																																													
LIST PRICE																																																	
PIPE SIZE	6"	8"																																															
	\$1,037.00	\$1,262.00																																															
-4 .....	\$366.00	-15 .....	\$0.00																																														
<p><b>67500</b></p> 	<p><b>HUB &amp; SPIGOT SWING-CHECK TYPE</b></p> <table border="1"> <thead> <tr> <th colspan="4">LIST PRICE</th> </tr> <tr> <th>PIPE SIZE</th> <th>2"</th> <th>3"</th> <th>4"</th> </tr> </thead> <tbody> <tr> <td></td> <td>\$599.00</td> <td>\$937.00</td> <td>\$1,154.00</td> </tr> <tr> <th>PIPE SIZE</th> <th>6"</th> <th>8"</th> <th></th> </tr> <tr> <td></td> <td>\$1,658.00</td> <td>\$2,330.00</td> <td></td> </tr> </tbody> </table> <p><b>ADD FOR OPTIONS:</b></p> <table> <tr> <td>-10* .....</td> <td>\$0.00</td> <td>-30 .....</td> <td>\$187.00</td> </tr> <tr> <td>-15 .....</td> <td>0.00</td> <td></td> <td></td> </tr> </table> <p>* For Extension, Use -10 Option with Hub and Spigot Extension Pipe by Others.</p>	LIST PRICE				PIPE SIZE	2"	3"	4"		\$599.00	\$937.00	\$1,154.00	PIPE SIZE	6"	8"			\$1,658.00	\$2,330.00		-10* .....	\$0.00	-30 .....	\$187.00	-15 .....	0.00			<p><b>Backwater Valve OPTION DESCRIPTIONS</b></p> <ul style="list-style-type: none"> <li>-DH Double Hub</li> <li>-LBV Less Backwater Valve</li> <li>-VP Secured Face, Vandal-Proof Screws</li> <li>-1 Satin Finish Nikaloy Face</li> <li>-2 Satin Finish Bronze Face</li> <li>-4 Bronze Seat</li> <li>-5 Galvanized Cast Iron Parts</li> <li>-10 Threaded Bronze Cover</li> <li>-15 Open Flap</li> <li>-25 Flashing Clamp Device</li> <li>-28 12" Cast Iron Extension and Stem</li> <li>-29 24" Cast Iron Extension and Stem</li> <li>-30 2" Auxiliary Inlet with Bronze Plug</li> <li>-35 1/2" Primer Tap</li> </ul>																			
LIST PRICE																																																	
PIPE SIZE	2"	3"	4"																																														
	\$599.00	\$937.00	\$1,154.00																																														
PIPE SIZE	6"	8"																																															
	\$1,658.00	\$2,330.00																																															
-10* .....	\$0.00	-30 .....	\$187.00																																														
-15 .....	0.00																																																
<p><b>67600</b></p> 	<p><b>HUB &amp; SPIGOT SWING-CHECK TYPE</b></p> <table border="1"> <thead> <tr> <th colspan="3">LIST PRICE</th> </tr> <tr> <th>TYPE NO.</th> <th>PIPE SIZE</th> <th></th> </tr> </thead> <tbody> <tr> <td>67610</td> <td>10"</td> <td>\$3,806.00</td> </tr> <tr> <td>67612</td> <td>12"</td> <td>4,938.00</td> </tr> </tbody> </table> <p><b>ADD FOR OPTIONS:</b></p> <table> <tr> <td>-15 .....</td> <td>\$0.00</td> <td></td> <td></td> </tr> </table>	LIST PRICE			TYPE NO.	PIPE SIZE		67610	10"	\$3,806.00	67612	12"	4,938.00	-15 .....	\$0.00																																		
LIST PRICE																																																	
TYPE NO.	PIPE SIZE																																																
67610	10"	\$3,806.00																																															
67612	12"	4,938.00																																															
-15 .....	\$0.00																																																

<p><b>71000</b></p> 	<p><b>HYDRASAN® I WITH VACUUM BREAKER NON-FREEZE</b></p> <table border="1"> <thead> <tr> <th colspan="2">LIST PRICE</th> </tr> <tr> <th>SIZE</th> <th></th> </tr> </thead> <tbody> <tr> <td>4" Wall</td> <td>\$732.00</td> </tr> <tr> <td>6", 8" Wall</td> <td>732.00</td> </tr> <tr> <td>10", 12", 14" Wall</td> <td>757.00</td> </tr> <tr> <td>16", 18" Wall</td> <td>797.00</td> </tr> <tr> <td>20", 22", 24" Wall</td> <td>838.00</td> </tr> </tbody> </table> <p><b>ADD FOR OPTIONS:</b></p> <table border="1"> <tbody> <tr> <td>-52</td> <td>\$28.00</td> <td>-74</td> <td>\$21.00</td> </tr> <tr> <td>-54</td> <td>129.00</td> <td>-91</td> <td>100.00</td> </tr> <tr> <td>-72</td> <td>0.00</td> <td>-95</td> <td>87.00</td> </tr> <tr> <td>-73</td> <td>0.00</td> <td></td> <td></td> </tr> </tbody> </table>	LIST PRICE		SIZE		4" Wall	\$732.00	6", 8" Wall	732.00	10", 12", 14" Wall	757.00	16", 18" Wall	797.00	20", 22", 24" Wall	838.00	-52	\$28.00	-74	\$21.00	-54	129.00	-91	100.00	-72	0.00	-95	87.00	-73	0.00			<p><b>71450</b></p> 	<p><b>YARD HYDRANT, HEAVY-DUTY NON-FREEZE</b></p> <table border="1"> <thead> <tr> <th colspan="3">LIST PRICE</th> </tr> <tr> <th>SIZE</th> <th>71450 3/4" Connection</th> <th>71450-91 1" Connection</th> </tr> </thead> <tbody> <tr> <td>2' Bury</td> <td>\$669.00</td> <td>\$1,142.00</td> </tr> <tr> <td>3' Bury</td> <td>767.00</td> <td>1,182.00</td> </tr> <tr> <td>4' Bury</td> <td>803.00</td> <td>1,230.00</td> </tr> <tr> <td>5' Bury</td> <td>840.00</td> <td>1,277.00</td> </tr> <tr> <td>6' Bury</td> <td>868.00</td> <td>1,310.00</td> </tr> </tbody> </table> <p><b>ADD FOR OPTIONS:</b></p> <table border="1"> <tbody> <tr> <td>-91</td> <td>ABOVE</td> </tr> </tbody> </table>	LIST PRICE			SIZE	71450 3/4" Connection	71450-91 1" Connection	2' Bury	\$669.00	\$1,142.00	3' Bury	767.00	1,182.00	4' Bury	803.00	1,230.00	5' Bury	840.00	1,277.00	6' Bury	868.00	1,310.00	-91	ABOVE			
LIST PRICE																																																											
SIZE																																																											
4" Wall	\$732.00																																																										
6", 8" Wall	732.00																																																										
10", 12", 14" Wall	757.00																																																										
16", 18" Wall	797.00																																																										
20", 22", 24" Wall	838.00																																																										
-52	\$28.00	-74	\$21.00																																																								
-54	129.00	-91	100.00																																																								
-72	0.00	-95	87.00																																																								
-73	0.00																																																										
LIST PRICE																																																											
SIZE	71450 3/4" Connection	71450-91 1" Connection																																																									
2' Bury	\$669.00	\$1,142.00																																																									
3' Bury	767.00	1,182.00																																																									
4' Bury	803.00	1,230.00																																																									
5' Bury	840.00	1,277.00																																																									
6' Bury	868.00	1,310.00																																																									
-91	ABOVE																																																										
<p><b>71020</b></p> 	<p><b>HYDRASAN® I WITH VACUUM BREAKER MILD CLIMATE</b></p> <table border="1"> <thead> <tr> <th colspan="3">LIST PRICE</th> </tr> <tr> <th>SIZE</th> <th>3/4 F x 1" M</th> <th></th> </tr> </thead> <tbody> <tr> <td></td> <td></td> <td>\$638.00</td> </tr> </tbody> </table> <p><b>ADD FOR OPTIONS:</b></p> <table border="1"> <tbody> <tr> <td>-52</td> <td>\$28.00</td> <td>-74</td> <td>\$21.00</td> </tr> <tr> <td>-54</td> <td>129.00</td> <td>-91</td> <td>100.00</td> </tr> <tr> <td>-72</td> <td>0.00</td> <td>-95</td> <td>87.00</td> </tr> <tr> <td>-73</td> <td>0.00</td> <td></td> <td></td> </tr> </tbody> </table>	LIST PRICE			SIZE	3/4 F x 1" M				\$638.00	-52	\$28.00	-74	\$21.00	-54	129.00	-91	100.00	-72	0.00	-95	87.00	-73	0.00			<p><b>71600</b></p> 	<p><b>YARD HYDRANT, BOX TYPE NON-FREEZE</b></p> <table border="1"> <thead> <tr> <th colspan="3">LIST PRICE</th> </tr> <tr> <th>SIZE</th> <th>71600 3/4" Connection</th> <th>71600-91 1" Connection</th> </tr> </thead> <tbody> <tr> <td>2' Bury</td> <td>\$953.00</td> <td>\$1,103.00</td> </tr> <tr> <td>3' Bury</td> <td>1,025.00</td> <td>1,180.00</td> </tr> <tr> <td>4' Bury</td> <td>1,096.00</td> <td>1,256.00</td> </tr> <tr> <td>5' Bury</td> <td>1,176.00</td> <td>1,327.00</td> </tr> </tbody> </table> <p><b>ADD FOR OPTIONS:</b></p> <table border="1"> <tbody> <tr> <td>-52</td> <td>\$0.00</td> <td>-95</td> <td>\$87.00</td> </tr> <tr> <td>-91</td> <td>ABOVE</td> <td>-97</td> <td>87.00</td> </tr> </tbody> </table>	LIST PRICE			SIZE	71600 3/4" Connection	71600-91 1" Connection	2' Bury	\$953.00	\$1,103.00	3' Bury	1,025.00	1,180.00	4' Bury	1,096.00	1,256.00	5' Bury	1,176.00	1,327.00	-52	\$0.00	-95	\$87.00	-91	ABOVE	-97	87.00					
LIST PRICE																																																											
SIZE	3/4 F x 1" M																																																										
		\$638.00																																																									
-52	\$28.00	-74	\$21.00																																																								
-54	129.00	-91	100.00																																																								
-72	0.00	-95	87.00																																																								
-73	0.00																																																										
LIST PRICE																																																											
SIZE	71600 3/4" Connection	71600-91 1" Connection																																																									
2' Bury	\$953.00	\$1,103.00																																																									
3' Bury	1,025.00	1,180.00																																																									
4' Bury	1,096.00	1,256.00																																																									
5' Bury	1,176.00	1,327.00																																																									
-52	\$0.00	-95	\$87.00																																																								
-91	ABOVE	-97	87.00																																																								
<p><b>71050</b></p> 	<p><b>HYDRASAN® I WITH VACUUM BREAKER NON-FREEZE</b></p> <table border="1"> <thead> <tr> <th colspan="2">LIST PRICE</th> </tr> <tr> <th>SIZE</th> <th></th> </tr> </thead> <tbody> <tr> <td>2-3/4" Wall</td> <td>\$410.00</td> </tr> <tr> <td>4", 6", 8" Wall</td> <td>410.00</td> </tr> <tr> <td>10", 12", 14" Wall</td> <td>435.00</td> </tr> <tr> <td>16", 18" Wall</td> <td>475.00</td> </tr> <tr> <td>20", 22", 24" Wall</td> <td>515.00</td> </tr> </tbody> </table> <p><b>ADD FOR OPTIONS:</b></p> <table border="1"> <tbody> <tr> <td>-50</td> <td>\$0.00</td> <td>-74</td> <td>\$21.00</td> </tr> <tr> <td>-72</td> <td>0.00</td> <td>-91</td> <td>100.00</td> </tr> <tr> <td>-73</td> <td>0.00</td> <td></td> <td></td> </tr> </tbody> </table>	LIST PRICE		SIZE		2-3/4" Wall	\$410.00	4", 6", 8" Wall	410.00	10", 12", 14" Wall	435.00	16", 18" Wall	475.00	20", 22", 24" Wall	515.00	-50	\$0.00	-74	\$21.00	-72	0.00	-91	100.00	-73	0.00			<p><b>71650</b></p> 	<p><b>TRI-TEMP WALL HYDRANT, BOX TYPE NON-FREEZE</b></p> <table border="1"> <thead> <tr> <th colspan="3">LIST PRICE</th> </tr> <tr> <th>SIZE</th> <th>71650 3/4" Connection</th> <th>71650-91 1" Connection</th> </tr> </thead> <tbody> <tr> <td>6", 8" Wall</td> <td>\$1,807.00</td> <td>\$2,004.00</td> </tr> <tr> <td>10", 12", 14" Wall</td> <td>1,858.00</td> <td>2,055.00</td> </tr> <tr> <td>16", 18" Wall</td> <td>2,017.00</td> <td>2,214.00</td> </tr> <tr> <td>20", 22", 24" Wall</td> <td>2,118.00</td> <td>2,315.00</td> </tr> </tbody> </table> <p><b>ADD FOR OPTIONS:</b></p> <table border="1"> <tbody> <tr> <td>-72</td> <td>\$0.00</td> <td>-81</td> <td>\$66.00</td> </tr> <tr> <td>-73</td> <td>0.00</td> <td>-91</td> <td>ABOVE</td> </tr> <tr> <td>-74</td> <td>43.00</td> <td>-95</td> <td>87.00</td> </tr> </tbody> </table>	LIST PRICE			SIZE	71650 3/4" Connection	71650-91 1" Connection	6", 8" Wall	\$1,807.00	\$2,004.00	10", 12", 14" Wall	1,858.00	2,055.00	16", 18" Wall	2,017.00	2,214.00	20", 22", 24" Wall	2,118.00	2,315.00	-72	\$0.00	-81	\$66.00	-73	0.00	-91	ABOVE	-74	43.00	-95	87.00
LIST PRICE																																																											
SIZE																																																											
2-3/4" Wall	\$410.00																																																										
4", 6", 8" Wall	410.00																																																										
10", 12", 14" Wall	435.00																																																										
16", 18" Wall	475.00																																																										
20", 22", 24" Wall	515.00																																																										
-50	\$0.00	-74	\$21.00																																																								
-72	0.00	-91	100.00																																																								
-73	0.00																																																										
LIST PRICE																																																											
SIZE	71650 3/4" Connection	71650-91 1" Connection																																																									
6", 8" Wall	\$1,807.00	\$2,004.00																																																									
10", 12", 14" Wall	1,858.00	2,055.00																																																									
16", 18" Wall	2,017.00	2,214.00																																																									
20", 22", 24" Wall	2,118.00	2,315.00																																																									
-72	\$0.00	-81	\$66.00																																																								
-73	0.00	-91	ABOVE																																																								
-74	43.00	-95	87.00																																																								
<p><b>71070</b></p> 	<p><b>HYDRASAN® I WITH VACUUM BREAKER MILD CLIMATE</b></p> <table border="1"> <thead> <tr> <th colspan="3">LIST PRICE</th> </tr> <tr> <th>SIZE</th> <th>3/4 F x 1" M</th> <th></th> </tr> </thead> <tbody> <tr> <td></td> <td></td> <td>\$316.00</td> </tr> </tbody> </table> <p><b>ADD FOR OPTIONS:</b></p> <table border="1"> <tbody> <tr> <td>-50</td> <td>\$0.00</td> <td>-74</td> <td>\$21.00</td> </tr> <tr> <td>-72</td> <td>0.00</td> <td>-91</td> <td>100.00</td> </tr> <tr> <td>-73</td> <td>0.00</td> <td></td> <td></td> </tr> </tbody> </table>	LIST PRICE			SIZE	3/4 F x 1" M				\$316.00	-50	\$0.00	-74	\$21.00	-72	0.00	-91	100.00	-73	0.00			<p><b>Hydrant OPTION DESCRIPTIONS</b></p> <ul style="list-style-type: none"> <li>-50 Satin Finish Bronze Face</li> <li>-52 Satin Finish Face, Cast Bronze Box</li> <li>-54 Satin Finish Face, Cast Nikaloy Box</li> <li>-72 Wall Clamp</li> <li>-73 Solder Inlet Adapter</li> <li>-74 Union Elbow Assembly</li> <li>-81 Vacuum Breaker</li> <li>-91 1" Hose Pipe Threaded Outlet</li> <li>-95 Cylinder Vandal-Proof Lock</li> <li>-97 1/8" Tapped Drain Hole in Box</li> </ul>																																				
LIST PRICE																																																											
SIZE	3/4 F x 1" M																																																										
		\$316.00																																																									
-50	\$0.00	-74	\$21.00																																																								
-72	0.00	-91	100.00																																																								
-73	0.00																																																										
<p><b>71400</b></p> 	<p><b>YARD HYDRANT NON-FREEZE</b></p> <table border="1"> <thead> <tr> <th colspan="2">LIST PRICE</th> </tr> <tr> <th>SIZE</th> <th>3/4" CONNECTION</th> </tr> </thead> <tbody> <tr> <td>2' Bury</td> <td>\$552.00</td> </tr> <tr> <td>3' Bury</td> <td>581.00</td> </tr> <tr> <td>4' Bury</td> <td>612.00</td> </tr> <tr> <td>5' Bury</td> <td>641.00</td> </tr> <tr> <td>6' Bury</td> <td>670.00</td> </tr> </tbody> </table>	LIST PRICE		SIZE	3/4" CONNECTION	2' Bury	\$552.00	3' Bury	581.00	4' Bury	612.00	5' Bury	641.00	6' Bury	670.00																																												
LIST PRICE																																																											
SIZE	3/4" CONNECTION																																																										
2' Bury	\$552.00																																																										
3' Bury	581.00																																																										
4' Bury	612.00																																																										
5' Bury	641.00																																																										
6' Bury	670.00																																																										

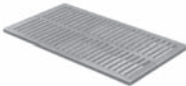

SHOCK ABSORBERS					
<b>75000</b> 	STAINLESS STEEL SHELL & ADAPTER		<b>75000-S</b> 	COPPER, PISTON TYPE	
	LIST PRICE			LIST PRICE	
	SIZE			SIZE	
A	\$262.00	AA	\$68.00		
B	530.00	A	106.00		
C	795.00	B	214.00		
D	1,991.00	C	323.00		
E	2,247.00	D	811.00		
F	2,762.00	E	969.00		
		F	1,124.00		

TRENCH DRAINS							
<b>76000</b> 	SUPER-FLO® 6" WIDE, RECTANGULAR			<b>76010</b> 	12" WIDE, RECTANGULAR		
	LIST PRICE				LIST PRICE		
	PIPE SIZE	2", 3", 4"	\$477.00		PIPE SIZE	3"-6"	\$1,119.00
ADD FOR OPTIONS:			ADD FOR OPTIONS:				
-EXT	\$477.00	-VP	\$109.00	-EXT	\$1,119.00	-30	\$69.00
-1	510.00	-30	71.00	-1	631.00	-40	295.00
-2	440.00	-40	147.00	-2	544.00	-70	260.00
-7	148.00	-X	0.00	-7	407.00	-70-40	422.00
2" and 3" Provided as 4" -X with Reducer.			3" Provided as 4" -X with Reducer.				
<b>76300</b> <b>76400</b> 	LIGHT-DUTY RECTANGULAR TRENCH DRAIN & ADDITIONAL SECTIONS						
	LIST PRICES						
	OPTIONS	76300 20" GRATE	76301 SINGLE GRATE & FRAME	76302 2-GRATE SECTION	76302 ADD'L. 20" 1-GRATE SECTION	76402 24" 2-GRATE SECTION	7640 ADD'L. 12" SECTIONS
	\$261.00	\$572.00	\$1,145.00	\$572.00	\$1,276.00	\$422.00	
ADD FOR OPTIONS:							
-1	\$982.00	\$1,576.00	\$2,498.00	\$922.00	\$2,597.00	\$1,301.00	
-7	289.00	579.00	1,158.00	579.00	1,158.00	579.00	
-8-2	875.00	1,378.00	2,196.00	819.00	2,290.00	1,193.00	
-VP	-----	216.00	432.00	216.00	432.00	216.00	
-40	147.00	224.00	448.00	224.00	448.00	215.00	
<b>76500</b> <b>76600</b> 	MEDIUM-DUTY RECTANGULAR TRENCH DRAIN & ADDITIONAL SECTIONS						
	LIST PRICES						
	OPTIONS	76500 24" GRATE	76501 SINGLE GRATE & FRAME	76502 2-GRATE SECTION	76502 ADD'L. 24" 1-GRATE SECTION	76602 24" 2-GRATE SECTION	7660 ADD'L. 12" SECTIONS
	\$333.00	\$903.00	\$1,393.00	\$876.00	\$1,669.00	\$765.00	
ADD FOR OPTIONS:							
-1	\$1,249.00	\$1,793.00	\$3,186.00	\$1,393.00	\$3,733.00	\$1,939.00	
-7	578.00	578.00	1,156.00	578.00	1,156.00	578.00	
-8-2	1,159.00	1,628.00	2,882.00	1,254.00	3,351.00	1,723.00	
-VP	-----	216.00	432.00	216.00	432.00	216.00	
-40	632.00	632.00	1,263.00	632.00	1,263.00	632.00	

## TRENCH DRAINS (cont'd)





<b>76700</b> <b>76800</b> 	HEAVY-DUTY RECTANGULAR TRENCH DRAIN & ADDITIONAL SECTIONS						
	LIST PRICES						
	OPTIONS	76700 24" GRATE	76701 SINGLE GRATE & FRAME	76702 2-GRATE SECTION	76702 ADD'L. 24" 1-GRATE SECTION	76802 24" 2-GRATE SECTION	7680 ADD'L. 12" SECTIONS
		\$589.00	\$1,217.00	\$2,125.00	\$907.00	\$1,770.00	\$769.00
<b>ADD FOR OPTIONS:</b>							
-1	\$1,897.00	\$2,981.00	\$5,628.00	\$2,648.00	\$4,864.00	\$2,017.00	
-7	624.00	624.00	1,248.00	624.00	1,248.00	624.00	
-8-2	1,753.00	2,619.00	5,022.00	2,405.00	4,313.00	1,807.00	
-VP	-----	216.00	432.00	216.00	432.00	216.00	
-40	709.00	709.00	1,418.00	709.00	1,418.00	709.00	

### TRENCH DRAIN OPTION DESCRIPTIONS

-EXT	Extension Section	-30	Flashing Clamp Device
-VP	* Secured Grate, Vandal-Proof Screws	-40	Galvanized Cast Iron Parts
-1	Satin Finish Nikaloy Top	-70	Sediment Bucket
-2	Satin Finish Bronze Top	-70-40	Sediment Bucket, Galvanized
-7	Ductile Iron Grate		
-8-2	All Bronze with Satin Finish Top	Outlet	
-11	Convex Grate	-X	Inside Caulk Outlet

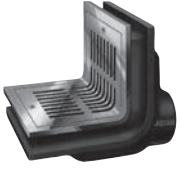







\* For Installations Exposed to Vehicular Traffic, Specify -VP, Secured Grate





## MISCELLANEOUS PRODUCTS

<b>85220</b> 	5" x 7" 90° ANGLE STRAINER			<b>85810</b> 	RECTANGULAR PATTERN DRAIN		
	LIST PRICE				LIST PRICE		
	PIPE SIZE	2", 3", 4"	\$760.00		PIPE SIZE	2", 3", 4"	\$224.00
<b>ADD FOR OPTIONS:</b>				<b>ADD FOR OPTIONS:</b>			
-3	\$309.00	-42	\$86.00	-1	\$277.00	-42	\$68.00
-VP	80.00	-47	270.00	-2	248.00	-47	227.00
-41	127.00	-T	0.00	-3	306.00	-T	36.00
				-VP	66.00	-X	0.00
<b>85800</b> 	RECTANGULAR PATTERN DRAIN			<b>85903-Z</b>  <b>NEW</b>	CAST IRON DRAIN WITH MEDIUM-DUTY SLOTTED GRATE		
	LIST PRICE				LIST PRICE		
	PIPE SIZE	4", 5", 6"	\$309.00		PIPE SIZE	3"	\$75.00
<b>ADD FOR OPTIONS:</b>				<b>ADD FOR OPTIONS:</b>			
-1	\$450.00	-42	\$68.00	-F4-93	\$79.00	-Z	0.00
-2	404.00	-47	270.00	-47	50.00		
-3	306.00	-T	0.00				
-VP	66.00						

### MISCELLANEOUS PRODUCT OPTION DESCRIPTIONS

-F4-93	Round Cast Iron Funnel	Outlets	
-VP	Secured Grate, Vandal-Proof Screws	-T	Threaded Outlet
-1	Satin Finish Nikaloy Top	-X	Inside Caulk Outlet
-2	Satin Finish Bronze Top	-Z	No-Hub Outlet
-3	Chrome Plated Bronze Face		
-41	Clamp Device		
-42	Ground Screw		
-47	Galvanized Cast Iron Parts		

	<b>P TRAP</b> <b>LIST PRICE</b>			<b>TRAP PRIMER ADAPTER</b> <b>LIST PRICE</b>		
	PIPE SIZE			PIPE SIZE	2", 3", 4"	\$87.00
	2"	\$203.00	<b>NEW</b>			
	3"	309.00				
	4"	461.00				
<b>ADD FOR OPTIONS:</b> -51 ..... \$69.00    -60 ..... \$93.00						
	<b>DEEP SEAL TRAP, FUNNEL INLET</b> <b>LIST PRICE</b>			<b>HUB ADAPTER, THREADED OUTLET</b> <b>LIST PRICE</b>		
	PIPE SIZE			PIPE SIZE		
	2"	\$337.00	3"	\$69.00		
	3"	390.00	4"	87.00		
			5"	180.00		
			6"	216.00		
<b>ADD FOR OPTIONS:</b> -8 (2") ..... \$263.00    -51 ..... \$69.00 -8 (3") ..... 585.00    -72 ..... 93.00			<b>ADD FOR OPTIONS:</b> -40 (3", 4") ..... \$32.00    -40 (6") ..... \$55.00 -40 (5") ..... 48.00			
	<b>TRAP SEAL PRIMER VALVE</b> <b>LIST PRICE</b>			<b>HUB ADAPTER, THREADED OUTLET</b> <b>LIST PRICE</b>		
	88250	\$134.00		PIPE SIZE		
<b>ADD FOR OPTIONS:</b> -10 ..... \$43.00    -91 ..... \$68.00 -90 ..... 0.00			2"	\$43.00		
	<b>TRAP SEAL PRIMER VALVE</b> <b>LIST PRICE</b>		3"	81.00		
	88300	POA*	4"	109.00		
• PRICE ON APPLICATION			5"	180.00		
	<b>NO-HUB SPIGOT ADAPTER</b> <b>LIST PRICE</b>		6"	209.00		
	PIPE SIZE		8"	383.00		
	2"	\$43.00	<b>ADD FOR OPTIONS:</b> -40 (2"-4") ..... \$36.00    -40 (5"-8") ..... \$56.00			
	3"	63.00				
	4"	100.00				
	6"	306.00				
	8"	342.00				
<b>ADD FOR OPTIONS:</b> -40 ..... \$39.00    -50 ..... 69.00 -49 ..... 69.00			<b>REDUCING HUB ADAPTER</b> <b>LIST PRICE</b>			
			TYPE NO.	PIPE SIZE		
			88603-2	2"	\$113.00	
			88603-2-1/2	2-1/2"	119.00	
			88604-2	2"	119.00	
			88604-2-1/2	2-1/2"	119.00	
			88604-3	3"	120.00	
			88606-4	4"	255.00	
<b>ADD FOR OPTIONS:</b> -40 ..... \$36.00						

<b>88900</b> 	<b>AIR GAP</b>	
	<b>LIST PRICE</b>	
	<b>TYPE NO.</b>	
	88900-1 \$138.00 88900-2 138.00 88900-3 166.00 88900-4 244.00 88900-5 577.00	
<b>ADD FOR OPTIONS:</b>		
-40 ..... \$96.00		
<b>88910</b> 	<b>AIR GAP</b>	
	<b>LIST PRICE</b>	
	<b>TYPE NO.</b>	
	88910-1 \$143.00 88910-2 143.00 88910-3 155.00 88910-4 199.00 88910-5 199.00	
<b>ADD FOR OPTIONS:</b>		
-40 ..... \$96.00		
<b>88950</b> 	<b>FRESH AIR INLET</b>	
	<b>LIST PRICE</b>	
	<b>PIPE SIZE</b>	
	2", 3", 4" \$264.00 5", 6" 450.00 8" 719.00	
<b>ADD FOR OPTIONS:</b>		
-2 (2" - 4")..... Deduct \$40.00    -2 (8")..... Deduct \$171.00 -2 (5", 6") ..... Deduct 97.00		
<b>88970</b> 	<b>FRESH AIR INLET</b>	
	<b>LIST PRICE</b>	
	<b>PIPE SIZE</b>	
	4" \$418.00 5" 476.00	
<b>ADD FOR OPTIONS:</b>		
-8-2 ..... Deduct \$150.00    -VP ..... 30.00		

### OPTION DESCRIPTIONS

- VP Secured Grate, Vandal-Proof Screws
- 2 Satin Finish Bronze Face
- 8 All Bronze
- 8-2 All Bronze with Satin Finish Face
- 10 Polished Chrome Plated
- 40 Galvanized Cast Iron Parts
- 49 3/4" Primer Tap
- 50 1/2" Primer Tap
- 51 Flushing Tap
- 60 Bronze Plug
- 72 Bronze Bucket
- 90 1/2" Female Copper Connection
- 91 1/2" Female IPS Union Connection

 <b>NEW</b>	PVC BODY WITH COLLAR		
	LIST PRICE		
	PIPE SIZE	2", 3", 4"	\$87.00
ADD FOR OPTIONS:			
-MD.....	\$50.00	-50.....	STD
-49.....	0.00	-S.....	0.00

 <b>NEW</b>	COMBINATION 3" x 4" PVC BODY FOR USE WITH ALL JOSAM STRAINERS		
	LIST PRICE		
	PIPE SIZE	3", 4"	\$30.00
ADD FOR OPTIONS:			
-S.....	\$0.00		

 <b>A Strainer</b>	ROUND NIKALOY SUPER-FLO® STRAINERS FOR PVC BODIES			
	LIST PRICE			
	Strainer	Strainer Only	With 30000-PVC	With 30300-PVC
5A	\$133.00	\$220.00	\$163.00	
6A	183.00	270.00	213.00	
7A	225.00	312.00	255.00	
8A	305.00	392.00	335.00	
9A	448.00	535.00	478.00	
10A	448.00	535.00	478.00	
ADD FOR OPTIONS:				
-SS (5A-8A).....	\$0.00	-80.....	\$50.00	
-2 (5A).....	Deduct 11.00	-5A-CP.....	20.00	
-2 (6A).....	Deduct 27.00	-6A-CP.....	22.00	
-2 (7A).....	Deduct 16.00	-J.....	174.00	
-2 (8A).....	Deduct 21.00	-VP.....	25.00	
-2 (9A, 10A).....	Deduct 28.00			

 <b>S Strainer</b>	SQUARE NIKALOY SUPER-FLO® STRAINERS FOR PVC BODIES			
	LIST PRICE			
	Strainer	Strainer Only	With 30000-PVC	With 30300-PVC
5S	\$208.00	\$295.00	\$238.00	
6S	242.00	329.00	272.00	
8S	390.00	477.00	420.00	
9S	519.00	606.00	549.00	
ADD FOR OPTIONS:				
-SS (5S-8S).....	\$0.00	-80.....	\$50.00	
-2 (5S).....	Deduct 25.00	-5S-CP.....	25.00	
-2 (6S).....	Deduct 16.00	-6S-CP.....	30.00	
-2 (8S).....	Deduct 44.00	-J.....	174.00	
-2 (9S).....	Deduct 50.00	-VP.....	25.00	

 <b>NEW</b>	PVC DRAIN ASSEMBLY, 9" ROUND TOP		
	LIST PRICE		
	PIPE SIZE	2", 3", 4"	\$170.00
ADD FOR OPTIONS:			
-HG.....	\$0.00	-50.....	\$50.00
-B.....	30.00	-S.....	0.00
-49.....	50.00		

 <b>NEW</b>	PVC DRAIN ASSEMBLY, 8" SQUARE CAST IRON TOP		
	LIST PRICE		
	PIPE SIZE	2", 3", 4"	\$295.00
ADD FOR OPTIONS:			
-1.....	\$282.00	-49.....	\$50.00
-2.....	209.00	-50.....	50.00
-15.....	109.00	-S.....	0.00

 <b>NEW</b>	PVC DRAIN ASSEMBLY, 12" SQUARE CAST IRON TOP		
	LIST PRICE		
	PIPE SIZE	2", 3", 4"	\$575.00
ADD FOR OPTIONS:			
-14.....	\$109.00	-20.....	\$418.00
-VP.....	66.00	-49.....	50.00
-18.....	253.00	-50.....	50.00
-19.....	505.00	-S.....	0.00

 <b>NEW</b>	PVC BODY/DOME ASSEMBLY WITH FULL GRATE		
	LIST PRICE		
	PIPE SIZE	2", 3", 4"	\$230.00
ADD FOR OPTIONS:			
-LG.....	Deduct \$100.00	-VP (NB).....	\$35.00
-HG.....	0.00	-16.....	195.00
-3Q.....	0.00	-17.....	288.00
-NB.....	347.00	-18.....	405.00
-3.....	0.00	-24.....	99.00
-4.....	0.00	-50.....	87.00
-5.....	501.00	-S.....	0.00
-7.....	81.00		

 <b>NEW</b>	COMBINATION 3" x 4" PVC ADJUSTABLE FLOOR CLEANOUT		
	LIST PRICE		
	PIPE SIZE	3" x 4"	\$250.00
ADD FOR OPTIONS:			
-2.....	Deduct \$17.00	-VP.....	\$43.00
-14.....	36.00	-S.....	0.00

### OPTION DESCRIPTIONS

- B Bucket
- CP Chrome Plated
- HG 1/2 Grate, PVC
- J Backwater Valve
- LG Less Grate
- MD PVC Clamp Collar with 3" Socket Connection
- NB Nickel Bronze Traffic Top
- SS Stainless Steel
- VP Secured Grate, Vandal-Proof Screws
- 1 Satin Finish Nikaloy Top
- 2 Satin Finish Bronze Top
- 3 1/2 Grate, Nickel Bronze
- 3Q 3/4 Grate, PVC
- 4 3/4 Grate, Nickel Bronze
- 5 Nikaloy Extra Heavy-Duty Grate & Rim
- 7 Full Grate with 2-1/2" Center Opening
- 14 Hinged Top
- 15 Chained Grate
- 16 Grate with 4" Round Funnel, NB Only
- 17 Grate with 6" Round Funnel, NB Only
- 18 Grate with 9" x 3-1/2" Oval Funnel, NB Only
- 19 CI Undergrate with Satin Finish Nikaloy Top
- 20 CI Undergrate with Satin Finish Bronze Top
- 24 Chained Grate, NB Only
- 49 3/4" Primer Tap
- 50 1/2" Primer Tap
- 80 Perforated Stainless Steel Basket

### Outlet

- S Solvent Weld Outlet for Schedule 40 PVC Pipe



## Prepackaged Products **ALWAYS AT JOSAM**

- *Hardware included in each package*
- *Durable and water resistant*
- *Customized labels for specific job requirements*
- *Quick and Easy Product Identification*
- *Accurate and on time shipping*

**JOSAM COMPANY** | [www.josam.com](http://www.josam.com)

### **CUSTOMER SERVICE CENTERS**

**JOSAM CORPORATE**  
525 West Highway 20  
Michigan City, IN 46360  
800.36.JOSAM | F 800.627.0008

**JOSAM EXECUTIVE**  
2501 S Front Street,  
Philadelphia, PA 19148  
215.339.5370 | F 800.962.3312

**JOSAM WEST**  
2333 Grant Ave,  
San Lorenzo, CA 94580  
510.481.6400 | F 800.995.6726